

**ARYMEX c.v.**

E. Carpentierlaan 43, 8500 KORTRIJK (Belgium)

Tel.: +32 (0)56 36 06 26 • Fax: +32 (0)56 36 06 66 • E-mail: info@arymex.be • www.arymex.be

[www.arymex.be](http://www.arymex.be)

The logo for arymex features the word "arymex" in a bold, blue, lowercase sans-serif font. A red circle is positioned above the letter 'y'. Below the text is a thick red horizontal bar. The background of the entire page is yellow, with a black silhouette of a city skyline and construction cranes at the bottom. Large, faint, overlapping circles in white and red are visible in the background.

***Catalogus 07-2023 - Catalogue 07-2023***

TEL:+32 (0)56 360626

e-mail : info@arymex.be

website: www.arymex.be



















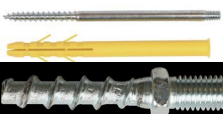



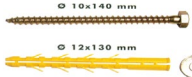



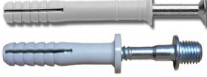









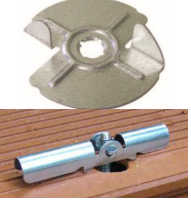

Wijzigingen voorbehouden

FAX:+32 (0)56 360666

BTW-TVA:BE 0462.747.111





Prijzen excl.BTW-Prix excl.TVA

Modifications réservées

<b>Fix-Ring MULTI</b> 	<b>Fix-Ring</b> 	<b>Fix-Ring CLIM</b> 	<b>Tub-Ring</b> 	<b>Flip</b> 	<b>AryClip</b> 
<b>Pg 5</b>	<b>Pg 6 → 7</b>	<b>Pg 7</b>	<b>Pg 8 → 9</b>	<b>Pg 10</b>	<b>Pg 11→15</b>
<b>IZY 6-7-8-10</b> 	<b>Rapido M6-8</b> 	<b>Beugel-Support Arco&amp;Ringschroef- Piton</b> 	<b>Aanzetschroef- Patte à vis &amp; Direct Beton</b> 	<b>Pug-Cheville RMT TORX T30 Ø8</b> 	<b>Pug-Cheville CQLT-R TORX T40</b> 
<b>Pg 16</b>	<b>Pg 17</b>	<b>Pg 18</b>	<b>Pg 19</b>	<b>Pg 20</b>	<b>Pg 20</b>
<b>Pug-Cheville CQLV TORX T40 Ø10</b> 	<b>Pug-Cheville CQLV TORX T30 Ø8</b> 	<b>Bevestiging Kit Fixation</b> 	<b>Plug CDM M8 Cheville CDM</b> 	<b>Plug CHO Cheville CHO</b> 	<b>Plug CTR Cheville CTR Ø8X68</b> 
<b>Pg 20</b>	<b>Pg 21</b>	<b>Pg 21</b>	<b>Pg 22</b>	<b>Pg 23</b>	<b>Pg 23</b>
<b>Vijs-Vis Torx T30</b> 	<b>Nagelplug- Cheville à frapper</b> 	<b>US Pluggen Chevilles US Ø6- 8-10-12</b> 	<b>Bevestiging Sanitaire Fixations</b> 	<b>Metaal Plug Cheville BRIK Métallique</b> 	<b>Alphagrip</b> 
<b>Pg 23</b>	<b>Pg 24</b>	<b>Pg 25</b>	<b>Pg 26</b>	<b>Pg 27</b>	<b>Pg 27</b>
<b>Tang-Pince BRIK ALPHAGRIP</b> 	<b>Plug GB Cheville</b> 	<b>Gyproc Plug Cheville Plak Metaal &amp; Nylon</b> 	<b>Gold plug Cheville Gold &amp; XL</b> 	<b>Pratico</b> 	<b>Clip Spantklem Clip bord de tôle</b> 
<b>Pg 27</b>	<b>Pg 28</b>	<b>Pg 28</b>	<b>Pg 29</b>	<b>Pg 30 → 31</b>	<b>Pg 31</b>
<b>Balkklem Suspente bord de tôle</b> 	<b>Spiegel bevestiging Fixation Miroir</b> 	<b>Steun Airco Support Climatisation</b> 	<b>RAPID M6</b> 	<b>Fix-Ring Elec</b> 	<b>Fix-Ring +</b> 
<b>Pg 32</b>	<b>Pg 33</b>	<b>Pg 33</b>	<b>Pg 34</b>	<b>Pg 35</b>	<b>Pg 35</b>
<b>Mini-Ring &amp; Fix Tub Elec</b> 	<b>Fast-Ring</b> 	<b>Clou-Elec</b> 	<b>Fix-Elec</b> 	<b>Connect-Ring</b> 	<b>Eco-Ring</b> 
<b>Pg 36</b>	<b>Pg 37</b>	<b>Pg 38</b>	<b>Pg 39</b>	<b>Pg 40</b>	<b>Pg 40</b>

<b>Speedy-Fix</b> 	<b>Fix-Suspent</b> 	<b>Fix-Asphalte</b> 	<b>Fix-Alu M6 &amp;M8</b> 	<b>Isolatie pluggen Chevilles pour isolants</b> 	<b>Isol-Fix</b> 
<b>Pg 41</b>	<b>Pg 42</b>	<b>Pg 43 → 44</b>	<b>Pg 45</b>	<b>Pg 46</b>	<b>Pg 46</b>
<b>Debis Gully</b> 	<b>Terugslagklep Clapet anti- retour</b> 	<b>Afvoer goten Caniveaux</b> 	<b>Pistolen-Pistolet</b> 	<b>SpeedyCut</b> 	<b>Knee RX</b> 
<b>Pg 47</b>	<b>Pg 48</b>	<b>Pg 49</b>	<b>Pg 50</b>	<b>Pg 51</b>	<b>Pg 52</b>
<b>AryKneeFlex</b> 	<b>Speedy schijf- Disque</b> 	<b>Abrasifs- Abrasives</b> 	<b>Diamant schijven &amp; Boren Disques diamantés &amp; Forets</b> 		
<b>Pg 53</b>	<b>Pg 54</b>	<b>Pg 55 → 57</b>	<b>Pg 58 → 71</b>		
<b>Boren voor professionelen Mèches pour professionnels</b>  alpen maykestag PERFORMANCE INTELLIGENT	<b>Gamma Zakjes-Gamme Sachets</b> 				
<b>Pg 72 → 106</b>	<b>pg 107 → 113</b>				

## Nieuw-Nouveau

<b>Fix-Ring MULTI</b>  <b>Pg 5</b> 	<b>Fix-Ring Ø38-40 &amp; 44-46</b>  <b>Pg 6</b>
<b>IZY 6 &amp; 10</b>  <b>Pg 16</b>	<b>Speciale Bevestiging Steunbeugel voor Aircó &amp; Warmtepompen - Fixaton Spécial support de Clim &amp; Pompe à Chaleur</b>  <b>Pg 18</b>

**Pug-Cheville CQLT-R Ø10 TORX T40**

**Pg 20**

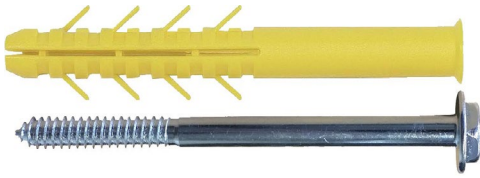

**Plug GOLD Cheville GOLD & XL**

**Gipsplaat -Plaque de plâtre**

**Pg 29**



**Pratico**

**Pg 30 - 31**



**Spantklem CLIP Bord de tôle**

**Pg 31**



**Metalen Balkklem-Suspente Bord de Tôle**

**Pg 32**



**Steun Airco Support Climatisation**

**Pg 33**



**Fix-Tub Elec**

**Pg 36**



**Abrasifs-Abrasive**

**Pg 55 → 57**

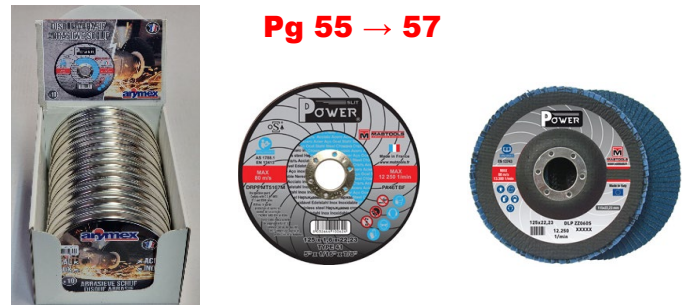

**Diamantboor Trépant diamanté**

Harde keramiek, graniet, marber (Droog)

Céramique dur, granit, marbre (à sec)

**Pg 58 → 71**



**Diamantboor Droog & Nat-Forets Sec et à eau**

Schijven Hout & Metaal-Disques Bois & Métal



**Pg 69 → 71**

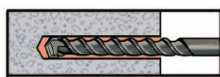

# Fix-Ring MULTI®



Ø 8 voor - pour Ø16-20  
Ø 10 voor - pour Ø22-26

Ref.	Ø	Bar code EAN13	Artikel-Article		
R180100	16-20	3509091801000	Fix-Ring MULTI Dubbel-Double Wit-Blanc	50	12
R180200	22-26	3509091802007	Fix-Ring MULTI Dubbel-Double Wit-Blanc	50	9
R181100	16-20	3509091811009	Fix-Ring MULTI Vierd.-Quadr. Wit-Blanc	25	12
R181200	22-26	3509091812006	Fix-Ring MULTI Vierd.-Quadr. Wit-Blanc	25	9

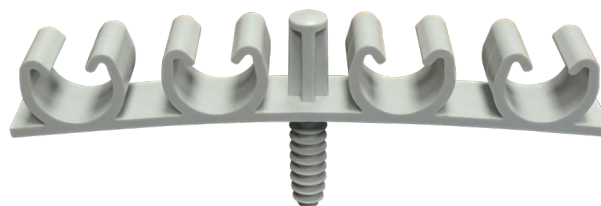

R185100	16-20	3509091851005	Fix-Ring MULTI Dubbel-Double Grijs-Gris	50	12
R185200	22-26	3509091852002	Fix-Ring MULTI Dubbel-Double Grijs-Gris	40	12
R186100	16-20	3509091861004	Fix-Ring MULTI Vierd.-Quadr. Grijs-Gris	25	12
R186200	22-26	3509091862001	Fix-Ring MULTI Vierd.-Quadr. Grijs-Gris	20	12

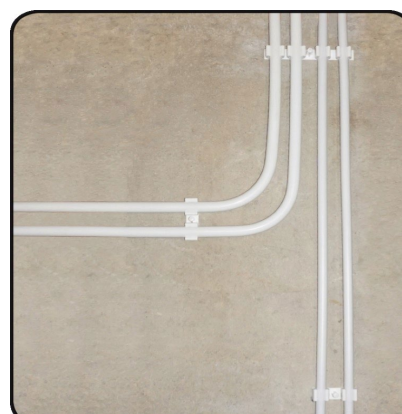
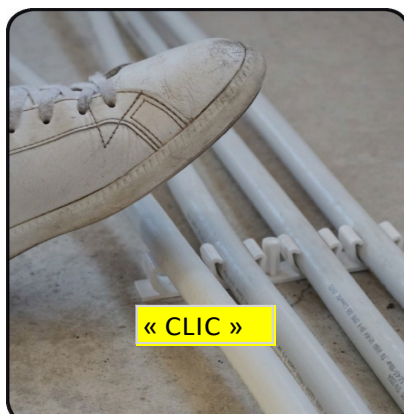
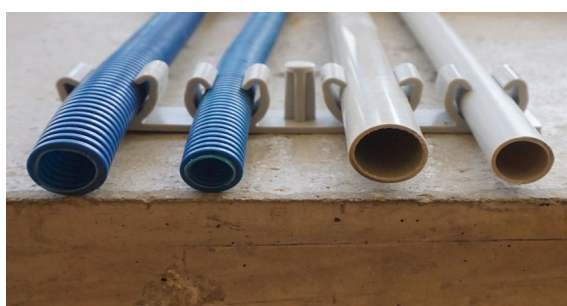



# Fix-Ring®





Ref.	Ø	Bar code EAN13	Artikel-Article			
R000900	14	3509090009001	Fix-Ring enkel-simple	Ø 8mm	100	16
R001000	16	3509090010007	Fix-Ring enkel-simple	Ø 8mm	100	16
R001100	18	3509090011004	Fix-Ring enkel-simple	Ø 8mm	100	16
R001200	20	3509090012001	Fix-Ring enkel-simple	Ø 8mm	100	16
R001300	22	3509090013008	Fix-Ring enkel-simple	Ø 8mm	100	16
R001400	25	3509090014005	Fix-Ring enkel-simple	Ø 8mm	100	12
R001500	28	3509090015002	Fix-Ring enkel-simple	Ø 8mm	100	12
R001600	32	3509090016009	Fix-Ring enkel-simple	Ø 8mm	50	16



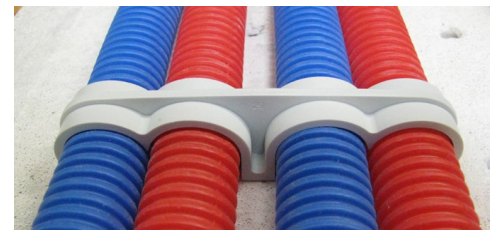

Ref.	Ø	Bar code EAN13	Artikel-Article			
R001900	16	3509090019000	Fix-Ring dubbel-double	Ø 8mm	100	16
R002000	18	3509090020006	Fix-Ring dubbel-double	Ø 8mm	100	12
R002100	20	3509090021003	Fix-Ring dubbel-double	Ø 8mm	100	12
R002200	22	3509090022000	Fix-Ring dubbel-double	Ø 8mm	100	9
R002300	25	3509090023007	Fix-Ring dubbel-double	Ø 8mm	100	9
R002400	28	3509090024004	Fix-Ring dubbel-double	Ø 8mm	50	12
R002500	38-40	3509090025001	Fix-Ring dubbel-double	NEW Ø 10mm	20	12
R002550	44-46	3509090025506	Fix-Ring dubbel-double	NEW Ø 10mm	20	12



Ref.	Ø	Bar code EAN13	Artikel-Article			
R002600	20-22	3509090026008	Fix-Ring vierdubbel-quadruple	Ø 8mm	50	12
R002700	25-26	3509090027005	Fix-Ring vierdubbel-quadruple	Ø 8mm	50	9

## Fix-Ring® Emmers-Seaux



Ref.	Ø	Bar code EAN13	Artikel-Article		
R100100	16	5425003481000	Fix-Ring enkel-simple	300	16
R100200	20	5425003481024	Fix-Ring enkel-simple	250	16
R100300	22	5425003481031	Fix-Ring enkel-simple	200	16
R100400	25	5425003481048	Fix-Ring enkel-simple	200	16
R100500	28	3509091005002	Fix-Ring enkel-simple <span style="background-color: yellow; border-radius: 50%; padding: 2px;">NEW</span>	150	16
R100800	16DB	5425003481086	Fix-Ring dubbel-double	200	16
R100900	20DB	5425003481093	Fix-Ring dubbel-double	150	16
R101000	22DB	5425003481109	Fix-Ring dubbel-double	140	16
R101200	25DB	5425003481208	Fix-Ring dubbel-double	100	16
R101300	28DB	3509091013007	Fix-Ring dubbel-double <span style="background-color: yellow; border-radius: 50%; padding: 2px;">NEW</span>	90	16
R101600	25 VD.QD.	3509091016008	Fix-Ring vierdubbel-quadruple <span style="background-color: yellow; border-radius: 50%; padding: 2px;">NEW</span>	60	16

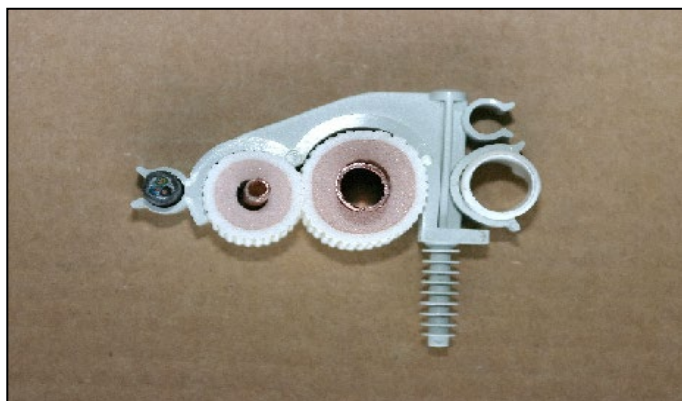

## Fix-Ring Clim®



Ref.	Ø	Bar code EAN13	Artikel-Article		
R200500	32-25	3509093131105	Fix-Ring Clim	50	9

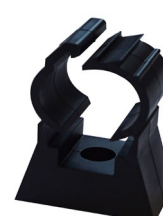
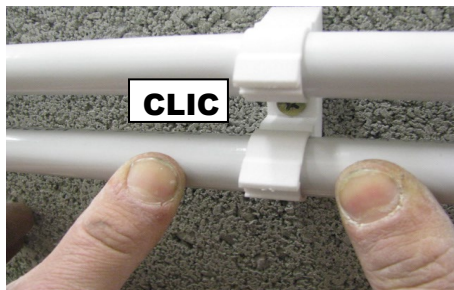

# Tub-Ring®



Ref.	Ø	Bar code EAN13	Artikel-Article		
T090030	15-16	3509093151103	Tub-Ring enkel-simple Wit-Blanc	100	16
T090040	20	3509093151202	Tub-Ring enkel-simple Wit-Blanc	100	12
T090050	25-26	3509093151301	Tub-Ring enkel-simple Wit-Blanc	50	16
T090060	32	3509090900605	Tub-Ring enkel-simple Wit-Blanc	30	16
T090030GY	15-16	5425003489167	Tub-Ring enkel-simple Grijs-Gris	100	16
T090040GY	20	5425003489174	Tub-Ring enkel-simple Grijs-Gris	100	12
T090050GY	25-26	5425003489181	Tub-Ring enkel-simple Grijs-Gris	50	16
T092030	15-16	3509090920306	Tub-Ring enkel-simple Zwart-Noir	100	16
T092040	20	3509090920405	Tub-Ring enkel-simple Zwart-Noir	100	12
T092050	25-26	3509090920504	Tub-Ring enkel-simple Zwart-Noir	50	16
T092060	32	3509090920603	Tub-Ring enkel-simple Zwart-Noir	30	16

NEW



Ref.	Ø	Bar code EAN13	Artikel-Article		
T090330	15-16	3509093152209	Tub-Ring dubbel - double Wit-Blanc	50	16
T090340	20	3509093152308	Tub-Ring dubbel - double Wit-Blanc	50	12
T090350	25-26	3509093152407	Tub-Ring dubbel - double Wit-Blanc	40	12
T090330GY	15-16	5425003489464	Tub-Ring dubbel - double Grijs-Gris	50	16
T090340GY	20	5425003489471	Tub-Ring dubbel - double Grijs-Gris	50	12
T090350GY	25-26	5425003489488	Tub-Ring dubbel - double Grijs-Gris	40	12
T092330	15-16	3509090923307	Tub-Ring dubbel - double Zwart-Noir	50	16
T092340	20	3509090923406	Tub-Ring dubbel - double Zwart-Noir	50	12
T092350	25-26	3509090923505	Tub-Ring dubbel - double Zwart-Noir	40	12

NEW





# Tub-Ring®



**Geleverd met vijzen 4,5x40 ,pluggen Ø8 + boor SDS+ Ø 8**



**Livré avec vis 4,5x40,chevilles Ø8 + mèche SDS+ Ø 8**

Ref.	Ø	Bar code EAN13	Artikel-Article		
T190030	15-16	5425003489037	Tub-Ring enkel-simple Wit-Blanc	180	16
T190040	20	5425003489044	Tub-Ring enkel-simple Wit-Blanc	150	16
T190050	25-26	5425003489051	Tub-Ring enkel-simple Wit-Blanc	120	16
T190330	15-16DB	5425003489334	Tub-Ring dubbel-double Wit-Blanc	110	16
T190340	20DB	5425003489341	Tub-Ring dubbel-double Wit-Blanc	80	16
T190350	25-26DB	5425003489358	Tub-Ring dubbel-double Wit-Blanc	50	16



**Geleverd met vijzen 4,5x40 ,pluggen Ø6 + boor SDS+ Ø 6**

**Livré avec vis 4,5x40,chevilles Ø6 + mèche SDS+ Ø 6**

Ref.	Ø	Bar code EAN13	Artikel-Article		
T290030	15-16	5425003489136	Tub-Ring enkel-simple Grijs-Gris	180	16
T290040	20	5425003489143	Tub-Ring enkel-simple Grijs-Gris	150	16
T290050	25-26	5425003489150	Tub-Ring enkel-simple Grijs-Gris	120	16
T290330	15-16DB	5425003489433	Tub-Ring dubbel-double Grijs-Gris	110	16
T290340	20DB	5425003489440	Tub-Ring dubbel-double Grijs-Gris	80	16
T290350	25-26DB	5425003489457	Tub-Ring dubbel-double Grijs-Gris	50	16

# Rapid-Tub®



**Geleverd met zelf borende vijzen 4,2x25 + vierkant hulpstuk**

**Livré avec vis auto perceuse 4,2x25 + embout carré**

**Bevestiging voor buizen op plaatijzer en Bardage**

**Pose de tube sur Tole et Bardage**



Ref.	Ø	Bar code EAN13	Artikel-Article		
T390030	15-16	5425003489235	Rapid-Tub enkel-simple Grijs-Gris	180	16
T390040	20	5425003489242	Rapid-Tub enkel-simple Grijs-Gris	150	16
T390330	15-16DB	5425003489266	Rapid-Tub dubbel-double Grijs-Gris	110	16
T390340	20DB	5425003489280	Rapid-Tub dubbel-double Grijs-Gris	80	16

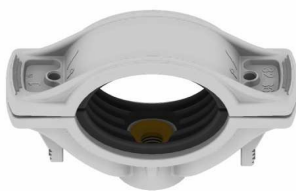

Ref.	Ø	Bar code EAN13	Artikel-Article		
31B1195	14-18	5425003481956	Beugel-Collier FLIP ISO 3/8" M8	30	12
31B1200	20-24	5425003482007	Beugel-Collier FLIP ISO 1/2" M8	30	12
31B1205	25-30	5425003482052	Beugel-Collier FLIP ISO 3/4" M8	30	12
31B1210	32-36	5425003482106	Beugel-Collier FLIP ISO 1" M8	25	12
31B1215	38-44	5425003482151	Beugel-Collier FLIP ISO 1 1/4" M8	20	12
31B1220	44-50	5425003482205	Beugel-Collier FLIP ISO 1 1/2" M8-M10	20	12
31B1225	56-62	5425003482250	Beugel-Collier FLIP ISO 2" M8-M10	15	12
31B1230	74-80	5425003482304	Beugel-Collier FLIP ISO 2 1/2" M8-M10	10	12
31B1235	84-90	5425003482359	Beugel-Collier FLIP ISO 3" M8-M10	10	12

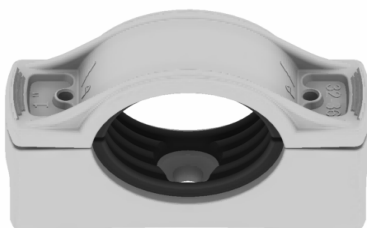

Ref.	Ø	Bar code EAN13	Artikel-Article		
31R1245	14-18	5425003482458	Beugel-Collier FLIP ISO 3/8" R	30	12
31R1250	20-24	5425003482502	Beugel-Collier FLIP ISO 1/2" R	30	12
31R1255	25-30	5425003482557	Beugel-Collier FLIP ISO 3/4" R	30	12
31R1260	32-36	5425003482601	Beugel-Collier FLIP ISO 1" R	25	12
31R1265	38-44	5425003482656	Beugel-Collier FLIP ISO 1 1/4" R	20	12
31R1270	44-50	5425003482700	Beugel-Collier FLIP ISO 1 1/2" R	20	12
31R1275	56-62	5425003482755	Beugel-Collier FLIP ISO 2" R	15	12
31R1280	74-80	5425003482809	Beugel-Collier FLIP ISO 2 1/2" R	10	12
31R1285	84-90	5425003482854	Beugel-Collier FLIP ISO 3" R	10	12

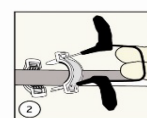
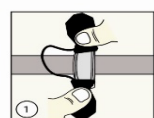
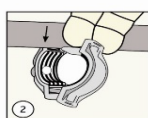
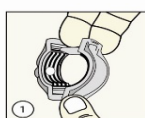
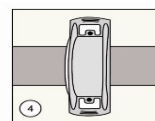
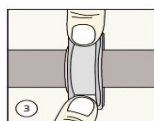
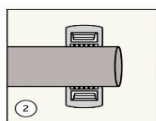
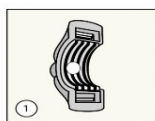

# AryClip

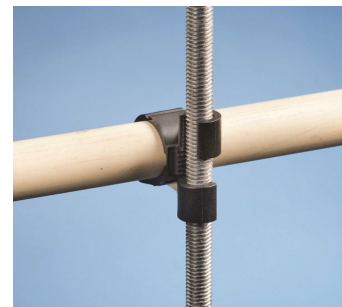
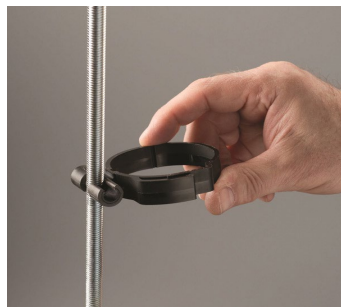

## Voor draadstang M8 - Pour tige filetée M8

Ref.	∅		Bar Code EAN13	Artikel-Article	Zakje	
					Sachet	
4500210	6mm	1/4"	5425003484025	AryClip draad - Filet M8 (Nr6-1)	•10	
4500212	10mm	3/8"	5425003484032	AryClip draad - Filet M8 (Nr6-2)	10	
4500214	12mm	1/2"	5425003484049	AryClip draad - Filet M8 (Nr8)	10	
4500216	15mm		5425003484056	AryClip draad - Filet M8 (Nr9)	• 10	24
4500218	16mm	5/8"	5425003484063	Aryclip draad - Filet M8 (Nr10)	• 10	24
4500220	18-20mm	3/4"	5425003484070	Aryclip draad - Filet M8 (Nr20)	• 10	24
4500222	22mm	7/8"	5425003484087	Aryclip draad - Filet M8 (Nr30)	• 10	24
4500224	24-25mm	1"	5425003484094	Aryclip draad - Filet M8 (Nr40)	• 10	24
4500226	27-28mm	1" 1/8	5425003484100	Aryclip draad - Filet M8 (Nr50)	• 10	24
4500228	30-32-33-34mm	1"1/4	5425003484117	Aryclip draad - Filet M8 (Nr60)	• 10	24
4500230	35-36-38mm	1"3/8	5425003484124	Aryclip draad - Filet M8 (Nr70)	• 10	24
4500232	40-41mm	1"1/2	5425003484131	Aryclip draad - Filet M8 (Nr80)	• 10	18
4500234	42-44-46-47-48-mm	1"5/8	5425003484148	Aryclip draad - Filet M8 (Nr90)	• 10	18
4500236	50mm	2"	5425003484155	Aryclip draad - Filet M8 (Nr100)	• 10	18
4500238	53-54-56-58mm	2"1/8	5425003484162	Aryclip draad - Filet M8 (Nr110)	• 10	18

## Voor draadstang M10 - Pour tige filetée M10

Ref.	∅		Bar Code EAN13	Artikel-Article	Zakje	
					Sachet	
4500318	16mm	5/8"	5425003484247	Aryclip draad -Filet M10 (Nr10)	10	24
4500320	18-20mm	3/4"	5425003484254	Aryclip draad -Filet M10 (Nr20)	10	24
4500322	22mm	7/8"	5425003484261	Aryclip draad -Filet M10 (Nr30)	10	24
4500324	24-25mm	1"	5425003484278	Aryclip draad -Filet M10 (Nr40)	10	24
4500326	27-28mm	1" 1/8	5425003484285	Aryclip draad -Filet M10 (Nr50)	10	24
4500328	30-32-33-34mm	1"1/4	5425003484292	Aryclip draad -Filet M10 (Nr60)	10	24
4500330	35-36-38mm	1"3/8	5425003484308	Aryclip draad -Filet M10 (Nr70)	10	24
4500332	40-41mm	1"1/2	5425003484315	Aryclip draad -Filet M10 (Nr80)	10	18
4500334	42-44-46-47-48-mm	1"5/8	5425003484322	Aryclip draad -Filet M10 (Nr90)	10	18
4500336	50mm	2"	5425003484339	Aryclip draad -Filet M10 (Nr100)	10	18
4500338	53-54-56-58mm	2"1/8	5425003484346	Aryclip draad -Filet M10 (Nr110)	10	18

• = Stock

# AryClip

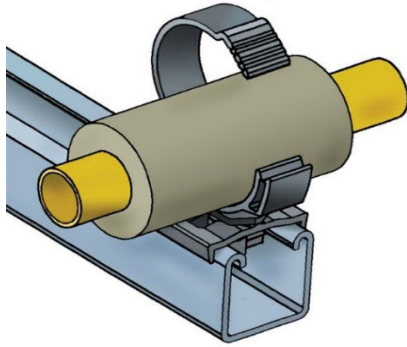

## Voor montage op Rail-Pour montage sur Rail WM1-WM2 30mm

Ref.	Ø		Bar Code EAN13	Artikel-Article	Zakje Sachet	
4500410	6mm	1/4"	5425003484407	Aryclip rail 30mm (Nr6-1)	10	
4500412	10mm	3/8"	5425003484414	Aryclip rail 30mm (Nr6-2)	10	
4500414	12mm	1/2"	5425003484421	Aryclip rail 30mm (Nr8)	10	
4500416	15mm		5425003484438	Aryclip rail 30mm (Nr9)	• 10	24
4500418	16mm	5/8"	5425003484445	Aryclip rail 30mm (Nr10)	• 10	24
4500420	18-20mm	3/4"	5425003484452	Aryclip rail 30mm (Nr20)	• 10	24
4500422	22mm	7/8"	5425003484469	Aryclip rail 30mm (Nr30)	• 10	24
4500424	24-25mm	1"	5425003484476	Aryclip rail 30mm (Nr40)	• 10	24
4500426	27-28mm	1" 1/8	5425003484483	Aryclip rail 30mm (Nr50)	• 10	24
4500428	30-32-33-34mm	1"1/4	5425003484490	Aryclip rail 30mm (Nr60)	• 10	18
4500430	35-36-38mm	1"3/8	5425003484506	Aryclip rail 30mm (Nr70)	• 10	18
4500432	40-41mm	1"1/2	5425003484513	Aryclip rail 30mm (Nr80)	• 10	18
4500434	42-44-46-47-48-mm	1"5/8	5425003484520	Aryclip rail 30mm (Nr90)	• 10	18
4500436	50mm	2"	5425003484537	Aryclip rail 30mm (Nr100)	• 10	12
4500438	53-54-56-58mm	2"1/8	5425003484544	Aryclip rail 30mm (Nr110)	• 10	12

## Voor montage op Rail-Pour montage sur Rail Strut 41mm

Ref.	Ø		Bar Code EAN13	Artikel-Article	Zakje Sachet	
4500518	16mm	5/8"	5425003484643	Aryclip rail 41mm (Nr10)	10	
4500520	18-20mm	3/4"	5425003484650	Aryclip rail 41mm (Nr20)	• 10	18
4500522	22mm	7/8"	5425003484667	Aryclip rail 41mm (Nr30)	10	18
4500524	24-25mm	1"	5425003484674	Aryclip rail 41mm (Nr40)	• 10	18
4500526	27-28mm	1" 1/8	5425003484681	Aryclip rail 41mm (Nr50)	• 10	18
4500528	30-32-33-34mm	1"1/4	5425003484698	Aryclip rail 41mm (Nr60)	• 10	18
4500530	35-36-38mm	1"3/8	5425003484704	Aryclip rail 41mm (Nr70)	• 10	12
4500532	40-41mm	1"1/2	5425003484711	Aryclip rail 41mm (Nr80)	• 10	12
4500534	42-44-46-47-48-mm	1"5/8	5425003484728	Aryclip rail 41mm (Nr90)	• 10	12
4500536	50mm	2"	5425003484735	Aryclip rail 41mm (Nr100)	10	12
4500538	53-54-56-58mm	2"1/8	5425003484742	Aryclip rail 41mm (Nr110)	• 10	12

• = Stock

# AryClip



## Met muurplug - Avec cheville murale Ø10

Ref.	Ø		Bar Code	Artikel-Article	Zakje	
			EAN13		Sachet	
4500118	16mm	5/8"	5425003484858	AryClip muurplug-Cheville murale (Nr10)	• 10	24
4500120	18-20mm	3/4"	5425003484865	AryClip muurplug-Cheville murale(Nr20)	• 10	24
4500122	22mm	7/8"	5425003484872	AryClip muurplug-Cheville murale(Nr30)	• 10	24
4500124	24-25mm	1"	5425003484889	AryClip muurplug-Cheville murale(Nr40)	• 10	24
4500126	27-28mm	1" 1/8	5425003484896	AryClip muurplug-Cheville murale(Nr50)	• 10	24
4500128	27-28mm	1" 1/9	5425003484902	AryClip muurplug-Cheville murale(Nr60)	• 10	24

• = Stock

# AryClip FR4

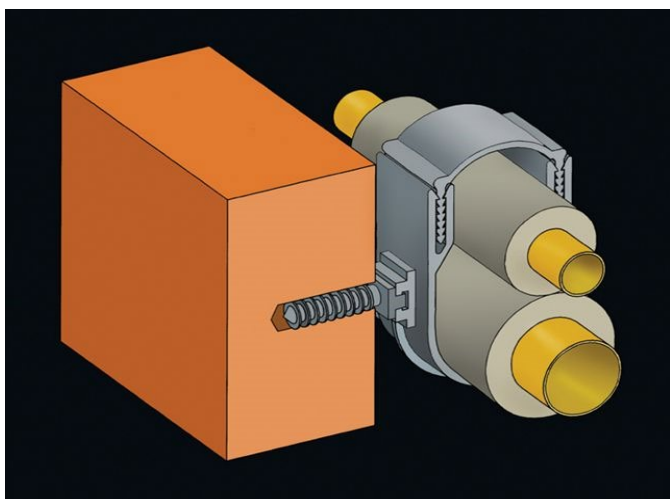
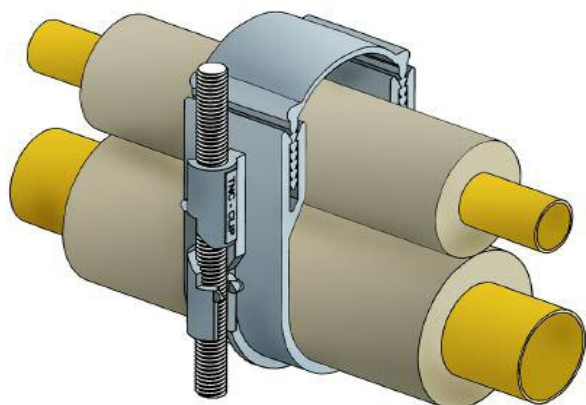

## Voor draadstang M8 - Pour tige filletée M8

Ref.	∅	Bar Code EAN13	Artikel-Article	Zakje Sachet	
45FR008	54mm & 38mm	5425003484179	Aryclip FR4 draad -Filet M8	• 5	12

## Voor draadstang M10-Pour tige filletée M10

Ref.	∅	Bar Code EAN13	Artikel-Article	Zakje Sachet	
45FR010	54mm & 38mm	5425003484353	Aryclip FR4 draad -Filet M10	• 5	12

## Muurplug - Cheville Murale

Ref.	∅	Bar Code EAN13	Artikel-Article	Zakje Sachet	
45FR001	54mm & 38mm	5425003484803	Aryclip FR4 Met muurplug Avec cheville murale	• 5	12

• = Stock

# AryClip 150SC&150CC

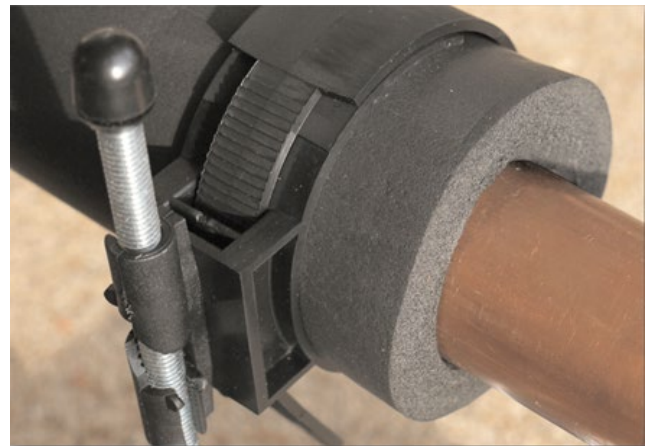
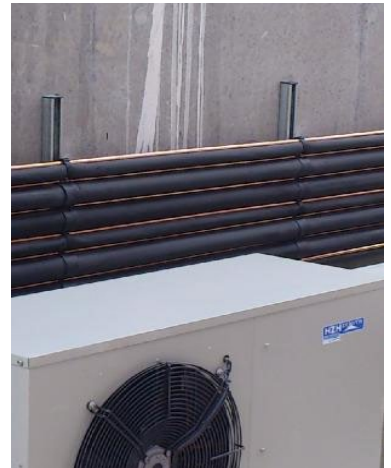
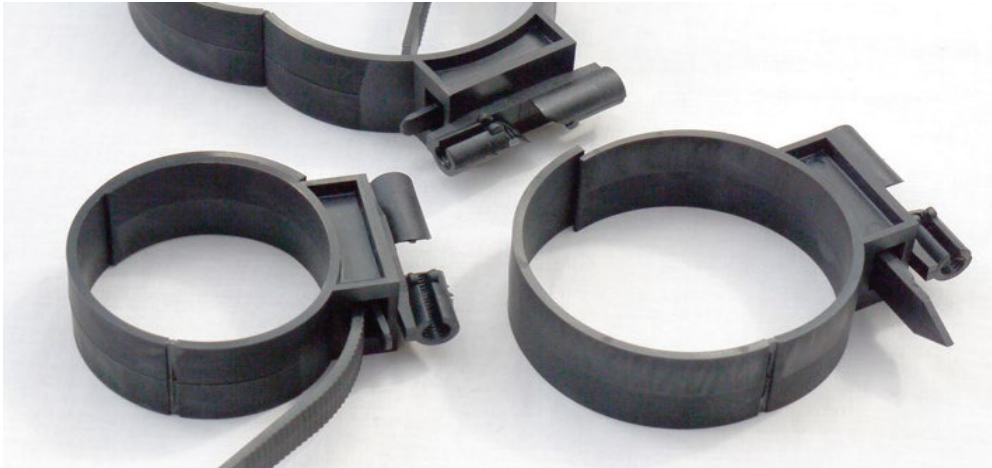

## Voor draadstang M8 - Pour tige filletée M8

Ref.	∅	Bar Code EAN13	Artikel-Article	Zakje Sachet	
<b>45SC008</b>	60mm & 80mm	5425003484186	Aryclip <b>150SC</b> draad -Filet M8	• 5	12

## Voor montage op Rail-Pour montage sur Rail Strut 41mm

Ref.	∅	Bar Code EAN13	Artikel-Article	Zakje Sachet	
<b>45CC010</b>	60mm & 80mm	5425003484759	Aryclip <b>150CC</b> Rail 41mm	• 5	12

• = Stock

**IZY 6-7-8-10**

# IZY 6 - IZY 7 - IZY 8 - IZY 10

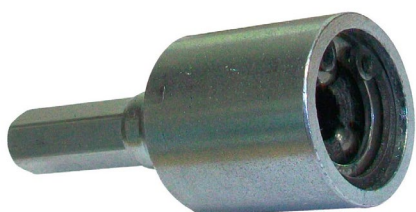

**Plaatsing gereedschap voor stokschroef  
Outil de pose pour patte à vis**



- ▶ LAAT TOE IN & UITVIJZEN
- ▶ TIJDWINST
- ▶ GEEN BESCHADIGING VAN DE SCHROEFDRAAD
- ▶ GEMAKKELIJK PLAATSEN
- ▶ DE STOCKSCHROEF HOUDT VAST IN HET GEREEDSCHAP
  
- ▶ PERMET DE VISSER et DÉVISSER
- ▶ GAIN DE TEMPS
- ▶ NE DÉTÉRIORE PAS LE FILET DE LA PATTE À VIS
- ▶ FACILITE LA POSE
- ▶ LA PATTE À VIS TIENT TOUTE SEULE DANS L'OUTIL



**Minibox 21 st/pcs**

Ref.	Bar code EAN13	Artikel-Article		
A149990	M6	3509091499900 IZY 6 Stuk - Pièce	1	
A150003	M7	3509091500033 IZY 7 Stuk - Pièce	1	
A150044	M8	3509091500446 IZY 8 Stuk - Pièce	1	
A150050	M10	3509091500507 IZY 10 Stuk - Pièce	1	
		<b>IZY 6-7-8-10 Minibox 21 stuks - 21 Pièces</b>	<b>1</b>	<b>21</b>



# RAPIDO®

## Schroef voor rechtstreekse ophanging in Beton Piton de suspension direct Béton



**100 Kg** Last met een toegepaste veiligheid coëfficiënt van 3

Charge pondérée avec un coefficient de sécurité de 3 appliqué.

Verpakt in handig plastic bakje met klep - Emballage pratique dans un bac plastique avec clapet

M6

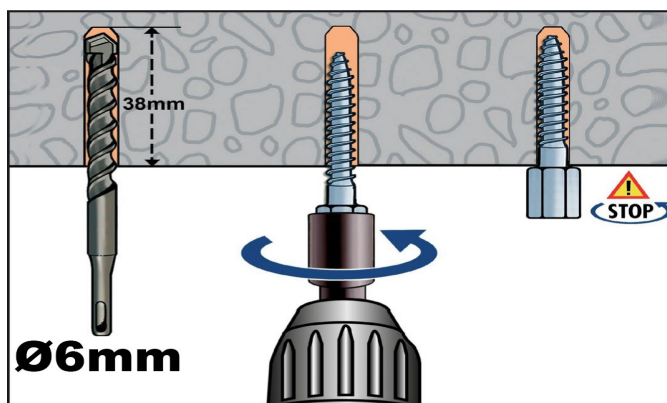

M8



**PAS DE CHEVILLE POSE RAPIDE - GEEN PLUG SNELLE PLAATSING  
GAIN DE TEMPS PERCAGE Ø 6 - TIJDSWINST BOORGAT Ø 6**

Ref.	Ø	Bar code EAN13	Artikel-Article		
V103010	M6	3509091880906	Rapido M6	100	10
V103030	M8	3509091881507	Rapido M8	100	10
A853350	M6	3509098533508	Rapido M6 zakje-Sachet 20st/pcs	20	20
A853360	M8	3509098533607	Rapido M8 zakje-Sachet 20st/pcs	20	20
V103005		3509092703457	Dopsleutel-Douille	1	

## Bevestiging steunbeugel Airco & Warmtepompen Fixation support de Clim & Pompe à chaleur

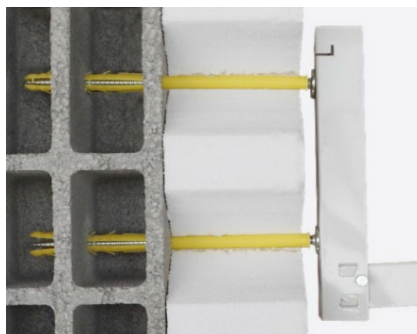

Volledige Kit - Kit complet

Plug met Anti-rotatie lamellen - Cheville avec ailettes ant-rotation

NEW

Voor alle materialen , ideaal voor holle ruimten - Pour tous les matériaux , idéal pour matériaux creux

**M10 Schroefdraadring voorkomt platdrukken van de isolatie  
Rondelle fileté M10 évite l'écrasement de l'isolant**



Vol: Ø 17mm Plein : Ø17mm  
Hol: Ø 16mm Creux : Ø16mm

Ref.	Ø	Bar code EAN13	Artikel-Article		
A150320	16x240	3509091503201	Kit Bevestiging steunbeugel-Fixation support Clim	1	€ 10,00
A150330	16x300	3509091503300	Kit Bevestiging steunbeugel-Fixation support Clim	1	€ 10,00

## Ringschroef - Piton



NEW

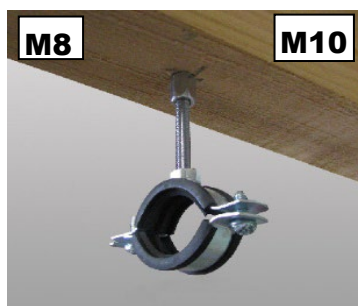

Ref.	Ø	Bar code EAN13	Artikel-Article		
A270310	M6	3509092703105	Ringschroef - Piton M6	100	10
A270325	M8	3509092703259	Ringschroef - Piton M8	100	10
A270330	M10	3509092703303	Ringschroef - Piton M10	20	10
V103005	M10	3509092703457	Dopsleutel-Douille	1	

## Vijs Direct Beton M8 -Vis direct Béton M8

NEW



M8



Ø 6 mm



ETE option 1

Gescheurd en ongescheurd beton  
Béton fissuré et non fissuré

Ref.	Ø	Bar code EAN13	Artikel-Article		
A244205	M8 16x35	3509092442059	Vijs Dubbel draad direct Beton M8 Vis Double filet direct Béton M8	50	10

## Lange Aanzetschroef -Patte à vis Longue

Handig - snel- regelbaar - geen verlengstuk nodig - Sleutel bijgeleverd in iedere doos

Facilité - Rapidité - Réglable - plus de rallonge nécessaire - Clé fournie dans chaque boîte

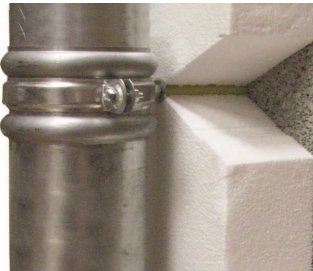

M8



Ø plug 10mm-Ø cheville 10mm



Ref.	Ø	Bar code EAN13	Artikel-Article	
A140035	M8 X 90	3509091400357	Lange aanzetschroef-Patte à vis longue	25
A140040	M8 X 130	3509091400401	Lange aanzetschroef-Patte à vis longue	25
A140050	M8 X 170	3509091400500	Lange aanzetschroef-Patte à vis longue	25
A140060	M8 X 210	3509091400609	Lange aanzetschroef-Patte à vis longue	25
A140070	M8 X 250	3509091400708	Lange aanzetschroef-Patte à vis longue	15
A140075	M8 X 290	3509091400753	Lange aanzetschroef-Patte à vis longue	15
A140080	M8 X 350	3509091400807	Lange aanzetschroef-Patte à vis longue	15

**RMT expantie plug met vijs TORX T30 (grote lengte)**  
**RMT Cheville d'expansion avec vis TORX T30 (grande longueur)**



Polyamide PA6

Ref.	Ø	Bar code EAN13	Artikel-Article		
401202	8x60	8590108401202	Expantie plug RMT TORX Cheville d'expansion Ø8	50	20
401219	8x80	8590108401219	Expantie plug RMT TORX Cheville d'expansion Ø8	50	20
401226	8x100	8590108401226	Expantie plug RMT TORX Cheville d'expansion Ø8	25	24
401233	8x120	8590108401233	Expantie plug RMT TORX Cheville d'expansion Ø8	25	24
401240	8x140	8590108401240	Expantie plug RMT TORX Cheville d'expansion Ø8	25	20

**Plug-Cheville CQLT-R Ø10**



Zeskantkop-Tête Hexagonal TH 13mm + Torx T40

Ref.	Ø	Bar code EAN13	Artikel-Article	
A150095	10x80	3509091500958	Cheville CQLT-R Ø 10 X 80	25
A150105	10x100	3509091501054	Cheville CQLT-R Ø 10 X 100	25
A150115	10x120	3509091501153	Cheville CQLT-R Ø 10 X 120	25
A150125	10x140	3509091501252	Cheville CQLT-R Ø 10 X 140	25
A150135	10x160	3509091501351	Cheville CQLT-R Ø 10 X 160	25
A150137	10x200	3509091501405	Cheville CQLT-R Ø 10 X 200	25

**Plug-Cheville CQLV Ø10**



Torx T40

Ref.	Ø	Bar code EAN13	Artikel-Article	
A090080	10x80	3509090900803	Cheville CQLV Ø 10 X 80	25
A090090	10x100	3509090900902	Cheville CQLV Ø 10 X 100	25
A090100	10x120	3509090901008	Cheville CQLV Ø 10 X 120	25
A090110	10x140	3509090901107	Cheville CQLV Ø 10 X 140	25
A090120	10x160	3509090901206	Cheville CQLV Ø 10 X 160	25
A090130	10x200	3509090901305	Cheville CQLV Ø 10 X 200	25
A090135	10x240	3509090901350	Cheville CQLV Ø 10 X 240	15
A090140	10x280	3509090901404	Cheville CQLV Ø 10 X 280	15

## Plug-Cheville CQLV Ø8

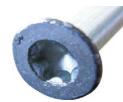

Torx T30

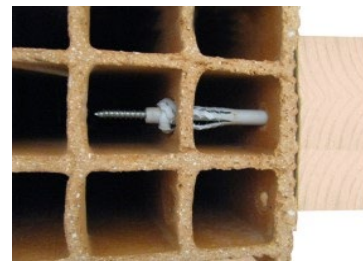

Agrément Technique Européen

Ref.	Ø	Bar code EAN13	Artikel-Article	
A090165	8x80	3509090901657	Cheville CQLV Ø 8 X 80	25
A090170	8x100	3509090901701	Cheville CQLV Ø 8 X 100	25
A090175	8x120	3509090901756	Cheville CQLV Ø 8 X 120	25
A090180	8x140	3509090901800	Cheville CQLV Ø 8 X 140	25

## Bevestiging Kit - Kit Fixation Ø 12 x 130

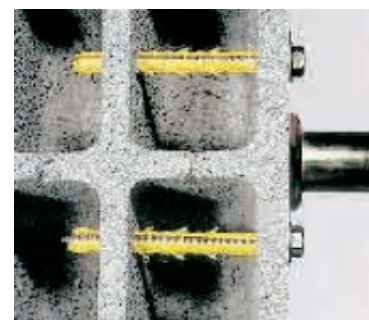
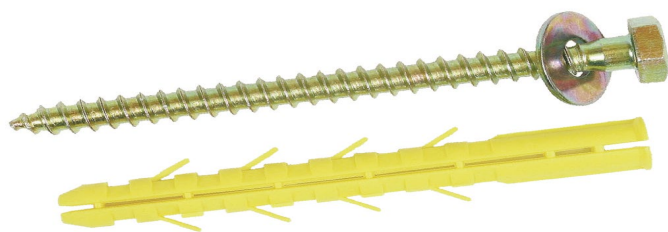

Bijzonderheid van deze plug is de uitzetting op heel haar lengte.

Gebruik voor het bevestigen van parabool, kabel goten, steun A.C., structuur klem, Boiler etc.....

Particularité de la cheville est l'expansion sur toute sa longueur.

Utilisations pour parabole, chemin de cables, supports A.C., sabot charpente, Boiler etc.....

Ref.	Ø	Bar code EAN13	Artikel-Article	Zakje Sachet	
A853035	12X130	3509098530354	Inhoud :4 Pluggen,4 ringschroeven,4 ringen Contenu : 4 chevilles,4 tirrefonds,4 rondelles	4	20

# Plug CDM - Cheville CDM



Bevestiging voor elektrische kasten,keuken elementen,badkamermeubel verwarming radiator,verwarmingsketel en vele andere toepassingen.

Fixation pour armoire électrique,élément de cuisine,chaudière murale meuble de salle de bains,radiateur de chauffage et d'autre applications.

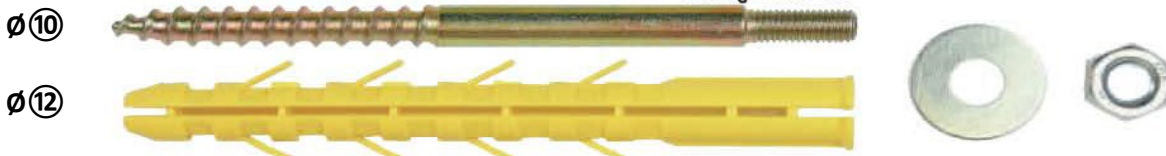

Ref.	Ø	Bar code EAN13	Artikel-Article	Zakje Sachet	
A160600	12X130	3509091606001	Inhoud :2 Pluggen,2 ringschroeven,2 ringen Contenu : 2 chevilles,2 tirrefonds,2 rondelles	2	20



Ref.	Ø	Bar code EAN13	Artikel-Article	Zakje Sachet	
------	---	-------------------	-----------------	-----------------	--

Voor isolatie tot 70mm - Pour isolation maxi 70mm

A160610	12X200	3509091606100	Inhoud :2 Pluggen,2 ringschroeven,2 ringen Contenu : 2 chevilles,2 tirrefonds,2 rondelles	2	10
---------	--------	---------------	--	---	----

Voor isolatie tot 110mm - Pour isolation maxi 110mm

A160620	12X240	3509091606209	Inhoud :2 Pluggen,2 ringschroeven,2 ringen Contenu : 2 chevilles,2 tirrefonds,2 rondelles	2	10
---------	--------	---------------	--	---	----

## Plug CHO - Cheville Ø 14 X 130

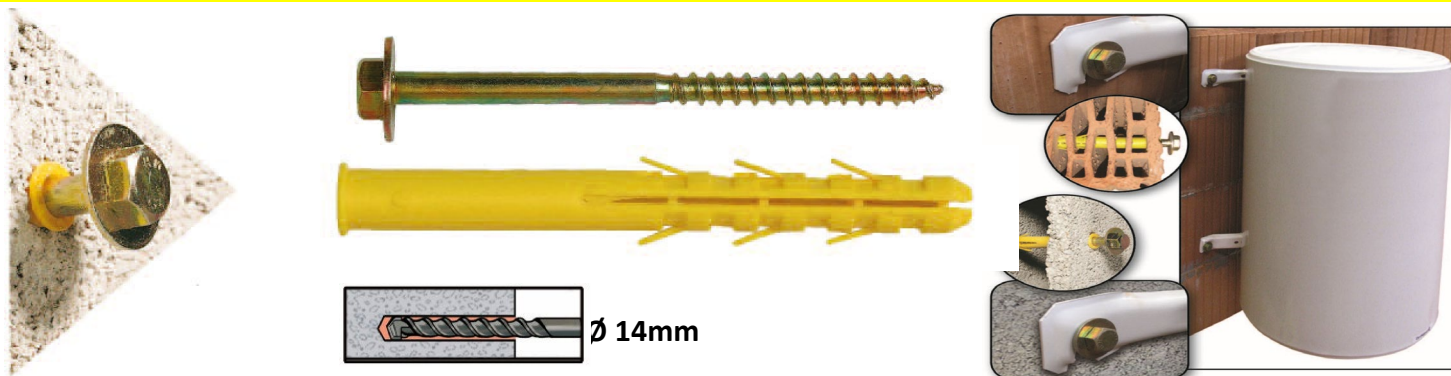

Handig systeem voor in bindsteen, holle stenen, zachte muren. De ring is aan de schroef gelast, dus kan de ring niet achter de voet glijden die te bevestigen is. Zeer handig.

Une idée simple et astucieux qui facilite les fixations sur parpaing ou briques creuses.

La rondelle est soudée au tirefond, donc elle ne passe pas derrière la patte à fixer, évitant ainsi le redémontage.

Ref.	Ø	Bar code EAN13	Artikel-Article	Zakje Sachet	
A150030	14X130	3509091500309	Inhoud :2 Pluggen,2 ringschroeven Contenu : 2 chevilles,2 tirefonds	4	10

## Plug CTR - Cheville Ø 8 X 68

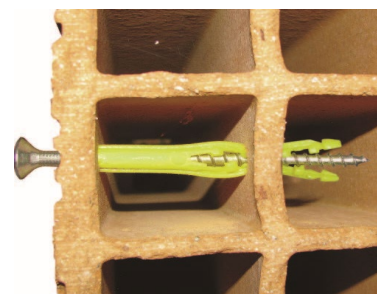

Een handige plug ,dankzij de 2 zijdelingse lippen kan de plug niet ronddraaien.

Zijn lengte van 68mm verzekert een sterke bevestiging. (Vijs van 5mm of 6mm Zie vijs Torx T30)

Une cheville astucieuse, grâce à ses 2 languettes la cheville ne tourne pas.

Sa longueur de 68mm assure une fixation solide. (Vis de 5mm ou 6mm. Voir vis Torx T30)

Ref.	Ø	Bar code EAN13	Artikel-Article		
A170500	8 X 68	3509091705001	Plug-Cheville CTR (Emmer-Seau)	150	12

## Vijs Torx T30(Platte Kop 14mm) - Vis Torx T30(Tête plate 14mm)



Ref.	Ø	Bar code EAN13	Artikel-Article	Zakje Sachet	
A860750	6 X 50	3509098607506	Vijs Torx - Vis Torx T30	50	5
A860755	6 X 70	3509098607551	Vijs Torx - Vis Torx T30	50	5
A860760	6 X 80	3509090802657	Vijs Torx - Vis Torx T30	50	5

Bits Torx T30 geleverd in iedere verpakking-Bits Torx T30 fourni dans conditionnement

# NagelPlug - Cheville à frapper

Verpakt in plastic bakje Handig voor op de werf  
Nouvelles Boîtes en plastique Pratique sur chantier

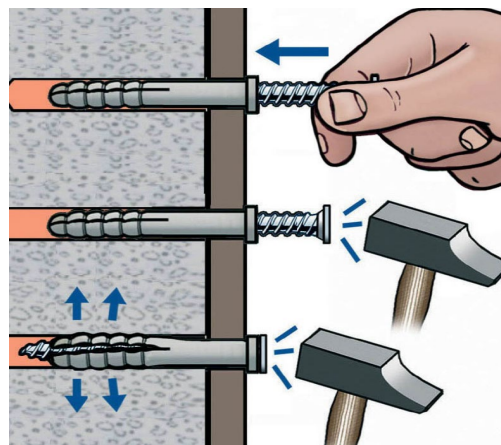

Polyamide PA6

Ref.	Ø	Bar code EAN13	Artikel-Article		
406818Z	5x45	8590108406818	Nagel Plug-NHZ-Cheville à Frapper	100	22
405552Z	6x40	8590108405552	Nagel Plug-NHZ-Cheville à Frapper	100	22
405583Z	6x60	8590108405583	Nagel Plug-NHZ-Cheville à Frapper	100	15
406412Z	6x80	8590108406412	Nagel Plug-NHZ-Cheville à Frapper	100	15
405965Z	8x60	8590108405965	Nagel Plug-NHZ-Cheville à Frapper	100	15
405975Z	8x75	8590108405972	Nagel Plug-NHZ-Cheville à Frapper	75	15
405989Z	8x80	8490108405989	Nagel Plug-NHZ-Cheville à Frapper	50	15
405996Z	8x100	8590108405996	Nagel Plug-NHZ-Cheville à Frapper	50	15
406009Z	8x120	8590108406009	Nagel Plug-NHZ-Cheville à Frapper	50	15

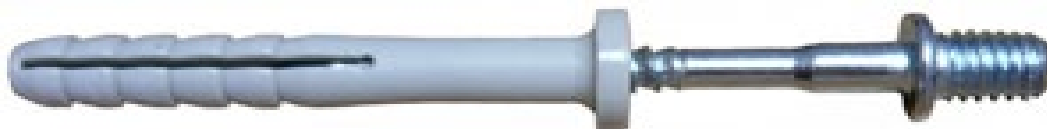

Polyamide PA6

Ref.	Ø - L	Bar code EAN13	Artikel-Article		
406467M	6x40	8590108406467	Nagel Plug-NHZ-Cheville à Frapper M6	200	15
406474M	8x60	8590108406474	Nagel Plug-NHZ-Cheville à Frapper M8	100	15



# UNIVERSELE US PLUGGEN CHEVILLES US UNIVERSELE

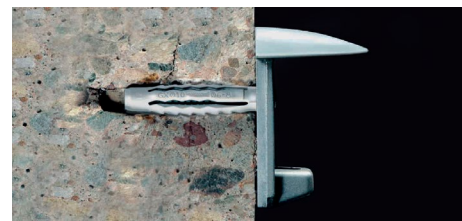

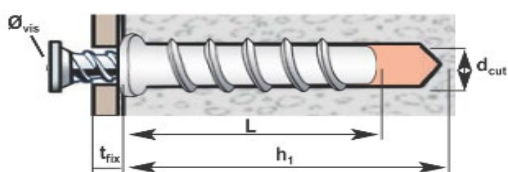

Verpakt in Emmer + **Boor** / Conditionement Seau + **Mèche**





## Boor-Mèche Long Life rond-ronde



Ref.	Ø - L	Bar code EAN13	Artikel-Article				
			h1	L	tfix		
31BFDSE06	6x30	5425003482465	45	30	10	600	24
31BFDSE08	8x40	5425003482489	55	40	10	250	24
31BFDSE10	10x50	5425003482410	65	50	10	100	24

## Boor-Mèche SDS+





Ref.	Ø - L	Bar code EAN13	Artikel-Article				
			h1	L	tfix		
31BSDSE06	6x30	5425003482403	45	30	10	600	24
31BSDSE08	8x40	5425003482427	55	40	10	250	24
31BSDSE10	10x50	5425003482434	65	50	10	100	24
31BSDSE12	12x60	5425003482441	80	60	15	75	15

Grote Hoeveelheid



Grande quantités

Ref.	Ø - L	Bar code EAN13	Artikel-Article				
			h1	L	tfix		
31B300006	6x30	5425003482908	45	30	10	3000	16
31B130008	8x40	5425003482915	55	40	10	1300	16
31B080010	10x50	5425003482922	65	50	10	800	16
31B040012	12x60	5425003482939	80	60	15	400	16

# Sanitaire bevestigingen - Fixations Sanitaire



WC bevestiging en Bidet **INOX** (met lange plug en dubbel doppen)  
Fixation WC et Bidet **INOX** (avec cheville longue et double capuchon)

Ref.	Ø	Bar code EAN13	Artikel-Article	Zakje Sachet
A500230	6X70	3509095002304	2 vis TH fendue Ø 6x70 <b>INOX</b> -2 vijzen TH Ø 6x70 <b>INOX</b> 2 chevilles nylon Ø 8x70 - 2 Nylon pluggen Ø 8x70 2 capuchons blancs - 2 doppen wit 2 capuchons chromés - 2 doppen chrom	40



Wastafel bevestiging en hangend WC  
Fixation lavabos et wc suspendus

Ref.	Ø	Bar code EAN13	Artikel-Article	Zakje Sachet
A500010	8X90	3509095000102	2 vis double filets-2 vijzen dubbel draad Ø 8	30
A500020	●8X110	3509095000201	2 écrous nylon à collerette - 2 nylon moeren Ø 8 2 chevilles Secur - 2 pluggen Ø 12	30
A500030	10x100	3509095000300	2 vis double filets-2 vijzen dubbel draad Ø 10	20
A500040	10x120	3509095000409	2 écrous nylon à collerette - 2 nylon moeren Ø 10	20
A500050	●10x140	3509095000508	2 chevilles Secur - 2 pluggen Ø 14	20

● stock

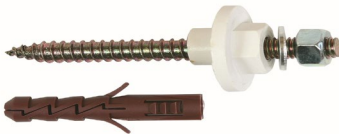

Wastafel bevestiging en hangend WC (met excentrisch ringen)  
Fixation lavabos et wc suspendus (avec rondelles excentrées)

Ref.	Ø	Bar code EAN13	Artikel-Article	Zakje Sachet
A500080	8X90	3509095000805	2 vis double filets-2 vijzen dubbel draad Ø 8 2 écrous nylon excentrées - 2 nylon moeren excentris Ø 8	30
A500090	●8X110	3509095000904	2 chevilles Secur - 2 pluggen Ø 12 2 écrous 2rondelles zingués-2 moeren,2 rondellen verzinkt	30
A500100	10x100	3509095001000	2 vis double filets-2 vijzen dubbel draad Ø 10 2 écrous nylon à collerette - 2 nylon moeren Ø 10	20
A500110	10x120	3509095001109	2 chevilles Secur - 2 pluggen Ø 14	20
A500120	●10x140	3509095001208	2 écrous 2rondelles zingués-2 moeren,2 rondellen verzinkt	20

● stock

# Metaal Plug BRIK voor hollewand + schroef

## Cheville métallique BRIK pour corps creux+vis

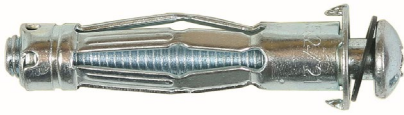

M4 : Ø 7 mm  
M5 : Ø 9 mm  
M6 : Ø 10 mm



### Technische kenmerken

- ▶ Ideaal voor lichte bevestiging in holle materialen(Gipsplaat, baksteen,Snelbouwers )
- ▶ Gebruik voor een optimale spreiding de speciale tang Brik.
- ▶ Anti-rotatie bij het aanspannen dankzij 2 pinnen
- ▶ 5 uitzettingarmen voor optimale uitzetting
- ▶ Verzinkt staal met metrische schroef

### Caractéristiques

- ▶ Idéale pour la fixation légère dans les matériaux creux (plaque de plâtre,brique, parpaing)
- ▶ Pour une parfaite expansion, utilisation recommandée de la pince BRIK
- ▶ Anti-rotation au serrage grâce aux 2 ergots
- ▶ 5 jambes d'expansion pour une expansion optimum
- ▶ Finition zinguée

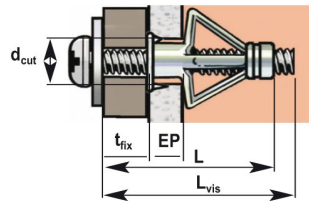
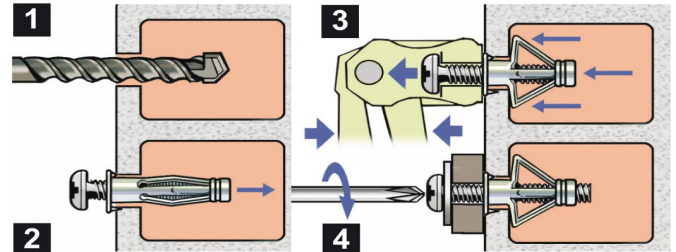

L : lengte plug (mm)  
d<sub>cut</sub> : boor diameter (mm)  
EP : dikte wand mini-maxi  
L : Longueur de la cheville (mm)  
d<sub>cut</sub> : Diamètre de perçage (mm)  
EP : Epaisseur de la paroi mini-maxi

Ref.	L mm	Bar code EAN13	Artikel-Article	kg	d <sub>cut</sub>	EP	
A506110	32	3509095061103	Plug-Cheville BRIK M4X32	12	8	3→12	100
A506115	46	3509095061158	Plug-Cheville BRIK M4X46	12	8	16→24	100
A506123	52	3509095061233	Plug-Cheville BRIK M5X52	18	11	3→16	100
A506125	65	3509095061257	Plug-Cheville BRIK M5X65	18	11	16→32	100
A506133	52	3509095061332	Plug-Cheville BRIK M6X52	20	13	3→16	100
A506135	65	3509095061356	Plug-Cheville BRIK M6X65	20	13	16→32	50

### ALPHAGRIP



Bevestiging wastafel-WC-Bidet  
Fixation lavabo-WC-Bidet

### Metaal plug met excentrische nylon ringen-Cheville métal et rondelle nylon excentrées

Ref.	Bar code EAN13	Artikel-Article		
A500635	Ø8x37	3509095006357	2 metaal pluggen,2 excentrich nylon ringen, 2 ringen en 2 moeren	20
A500640	Ø8x55	3509095006401	2 chevilles métal,2 rondelles nylon excentrées,2 écrous et 2 rondelles	20
A500645	Ø8x65	3509095006456		20



A220112		3509092201120	Tang-Pince BRIK N°5	1
A220109		3509092201090	Tang-Pince BRIK N°4 voor-pour Ø8	1

## Plug GB - Cheville

Voor celbeton en gipstegels - Pour béton cellulaire et carreaux de plâtre

- ▶ optimale houding in celbeton ▶ Tenue optimale dans le béton cellulaire
- ▶ Zeer goede temperatuur weerstand -40 tot + 80°C ▶ Très bonne tenue aux écarts de température -40 à 80° C
- ▶ Kan gebruikt worden met gewone vijs, slotschroef of metrische schroefbout ▶ Permet l'utilisation de vis ordinaire, tire-fond, ou boulon métrique
- ▶ Schroeven met 6 kantig hulpstuk ▶ Visser avec embout 6 pans

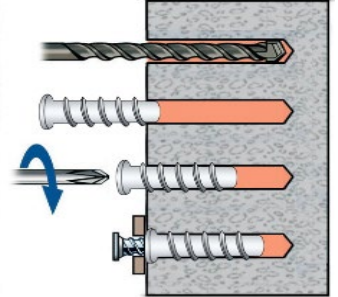
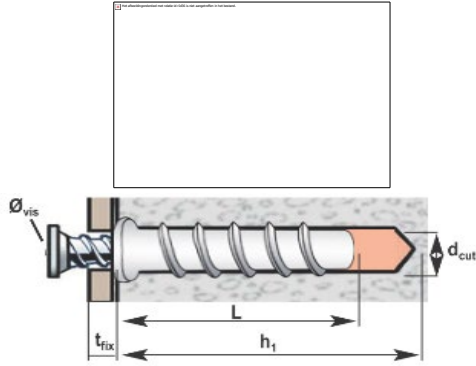

L: Lengte-Longueur (mm)

h1: Diepte boorgat-Profondeur de perçage (mm)

dcut: Ø boorgat-Ø de perçage (mm)

tfix: Epaisseur à fixer-Dikte te bevestigen (mm)

Øvis: Ø vijs-Ø vis (mm)

Ref.	Ø	Bar code EAN13	L	h1	dcut	Øvis	tfix	
A170410	GB6-M6	3509091704103	50	60	10	5-6 M6	5	25
A170415	GB8-M8	3509091704158	60	70	12	7-8 M8	10	25
A170420	GB10-M10	3509091704202	70	80	14	9-10 M10	10	10

## Gyproc plug-Nylon & Metal - Cheville Plak Nylon & Métal

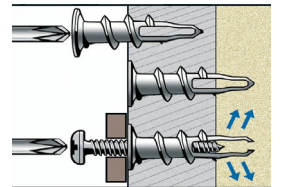
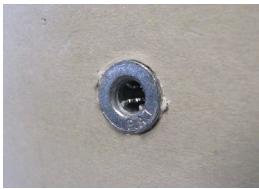

Ref.	Bar code EAN13	Artikel-Article	
A200010	3509092000105	Metaal Plug+Vijs-Cheville Métal+Vis	100
A200040	3509092000402	Nylon Plug+Vijs-Cheville Nylon+Vis	100

**GOLD**

## Plaatsen met hamer - Mise en place au marteau

Verzinkt staal - Corrosiebescherming

Eenvoudig en snel zonder te boren

Gekartelde punt: inbrengen gemakkelijk en nauwkeurig

Vuurbestendig

Geen rotatie bij het schroeven

Acier zingué-protection anticorrosion

Sans perçage simple et rapide

Pointe dentelée: insertion facile et précise

Résistant au feu

Pas de rotation au vissage

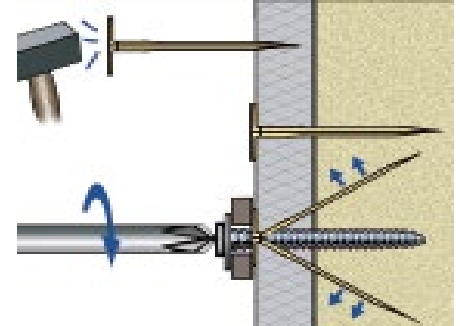

Gipsplaat tot 13mm , Vezelgipsplaat, fibro-cement , Geperste houtvezelplaat 3 tot 5mm

Plaque de plâtre jusqu'a 13mm , Plaque de plâtre fibrée, fibrociment ,Panneau fibres de bois compressées 3 à 5mm

**15kg**

Belast gewicht met een veiligheid coëff. van 2.

Charge pondérée coeff.de sécurité de 2

Ref.	Dikte Épaisseur	Bar code EAN13	Artikel-Article		
<b>A200060</b>		3509092000600	Plug GOLD + vijs 4x40 - Cheville GOLD + vis 4x40	100	10
<b>XL</b>					

Verzinkt staal - Corrosiebescherming

Eenvoudig en snel zonder te boren

Gekartelde punt: inbrengen gemakkelijk en nauwkeurig

Vuurbestendig

Geen rotatie bij het schroeven

Acier zingué-protection anticorrosion

Sans perçage simple et rapide

Pointe dentelée: insertion facile et précise

Résistant au feu

Pas de rotation au vissage



Dubbele gipsplaat Bouble Plaque de plâtre <b>30kg</b>
Cel Beton lage dchtheid Béton cellul.faible densité <b>35kg</b>
Cel Beton hoge dchtheid Béton cellul.forte densité <b>70kg</b>
Fibro cement(2x13mm) Béton cellul.forte densité <b>70kg</b>

Celbeton,Dubbele Gipsplaat tot 26mm(2x13) , Gipsplaat 18 tot20mm,Dubbele Vezelgipsplaat, fibro-cement(26mm)

Béton cellulaire,Bouble Plaque de plâtre jusqu'a 26mm,Plaque de plâtre 18à20mm, fibrociment 26mm

<b>A200090</b>		3509092000907	Plug XL + vijs 4X50- Cheville XL + vis 4x50	100	10
----------------	--	---------------	---	-----	----

# PRATICO® OUTIL AIMANTÉ MAGNETISCH GEREEDSCHAP

**POUR DIFFÉRENTES APPLICATIONS  
VOOR VERSCHILLENDE TOEPASSINGEN**



**UNE NOUVELLE FAÇON DE POSER : + FACILE !  
EEN NIEUWE MANIER VAN PLAATSEN : EENVOUDIG !**



**CLIP BORD DE TÔLE  
SPANTKLEM**



**CHEVILLE GOLD  
GOLD PLUG**



**POINTE  
NAGEL**



**VIS  
VIJS**



**ÉCROU  
MOER**



Ref.	Désignation - Omschrijving		
U160000	Uтил aimanté PRATICO Magnetisch gereedschap PRATICO	1	10

07-2023  
030

**PRATICO****Magnetisch gereedschap-Outil aimanté**

Voor verschillende toepassingen-Pour différentes applications



Plaatstalen randklem  
Clip bord de tôle

Gold plug  
Cheville Gold

Nagel  
Pointe

Vijs  
Vis

Moer  
Écrou

Ref.	Ø	Bar code EAN13	Artikel-Article		
U160000		3509091600009	Pratico Magnetisch gereedschap-Outil aimanté	1	10

**CLIP**

Toepassingen: kabel, buizen en leidingen

Applications: câbles tubes et gaine

Gehard staal - corrosiebescherming  
Snelle en eenvoudige montage  
Resistent voor Binnen en buiten



Acier trempé-protection anticorrosion  
Montage simple et rapide  
Résistant pour Interieur et extérieur



Ref.	Ø	Bar code EAN13	Artikel-Article		
A200200	6 ↔ 9	3509092002000	Stalen liggers Clip Bord de tôle ⇄ 2 ↔ 7mm	100	
A200210	6 ↔ 9	3509092002109	Stalen liggers Clip Bord de tôle ⇄ 7 ↔ 12mm	100	
A200220	10 ↔ 14	3509092002208	Stalen liggers Clip Bord de tôle ⇄ 2 ↔ 7mm	100	
A200230	10 ↔ 14	3509092002307	Stalen liggers Clip Bord de tôle ⇄ 7 ↔ 12mm	100	
A200240	15 ↔ 21	3509092002406	Stalen liggers Clip Bord de tôle ⇄ 2 ↔ 7mm	100	
A200250	15 ↔ 21	3509092002505	Stalen liggers Clip Bord de tôle ⇄ 7 ↔ 12mm	100	
A200260	22 ↔ 32	3509092002604	Stalen liggers Clip Bord de tôle ⇄ 2 ↔ 7mm	100	
A200270	22 ↔ 32	3509092002703	Stalen liggers Clip Bord de tôle ⇄ 7 ↔ 12mm	100	

# Metalen Balkklem-Suspente Bord de Tôle

Toepassingen: buizen en leidingen ,ventilatie,climatisatie,vals plafond,ophanglampen ...  
 Applications: tubes et gaine,éclairage suspendus,faux-plafond,ventilation,clim ....



Draadstang M6-M8 Tiges filetée

Veelzijdig: vaste draadstang, gladde stang, haak, ketting, staaldraad, kabel, .....  
 Polyvalent :fix tige filetée,tige lisse,crochet,chaînette,fil d'acier,câble , .....

Gehard staal - corrosiebescherming  
 Snelle en eenvoudige montage  
 Resistent voor binnen en buiten  
 Handmatige toepassing zonder gereedschap  
 3 afmetingen van 2 tot 24 mm  
 Statische belasting op draadstang M6 en M8 120kg

Acier trempé-protection anticorrosion  
 Montage simple et rapide  
 Résistant pour Interieur et extérieur  
 Pose manuelle sans outil  
 3 tailles pour supports de 2 à 24mm  
 Charge statique sur tige M6 et M8 120kg

Ref.	Dikte Épaisseur	Bar code EAN13	Artikel-Article		
A200300	2 ↔ 8mm	3509092003007	Metalen Balkklem-Suspente Bord de Tôle 2-8mm	50	
A200310	8 ↔ 16mm	3509092003106	Metalen Balkklem-Suspente Bord de Tôle 8-16mm	50	
A200320	16 ↔ 24mm	3509092003205	Metalen Balkklem-Suspente Bord de Tôle 16-24mm	25	





## Geveerde spiegel steun-Patte à glace à ressort

Spiegel bevestiging - Fixation de miroir

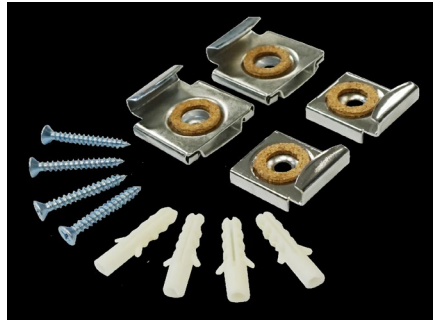

Verchromd  
Chromée

Ref.	Ø	Bar code EAN13	Artikel-Article	Zakje Sachet	
A186405		3509091484050	Geveerde spiegel steun-Patte à glace	4	10

## Steun voor Airco - Support de climatisation



Breedte regelbaar tot 78cm - Largeur réglable jusqu'a 78cm  
Met Silentbloc - avec Silentbloc

Ref.	Max gewicht Charge Max	Bar code EAN13	Artikel-Article	
A162020	115kg	3509091620205	Steun - support 1,5mm Dikte staal-Epaisseur acier	1



Breedte regelbaar tot 85cm - Largeur réglable jusqu'a 85cm  
Met Silentbloc - avec Silentbloc



Loodrecht afstelling -Réglage du faux aplomb

Ref.	Max gewicht Charge Max	Bar code EAN13	Artikel-Article	
A162010	120kg	3509091620106	Steun - support 1,5mm Dikte staal-Epaisseur acier	1

# Rondelle "RAPID" M6



Gemakkelijk schroeven  
Vissage facile

Vastdraaien met de hand  
Serrage à la main

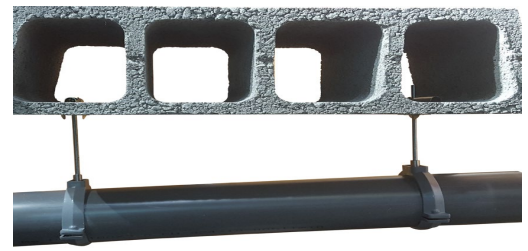
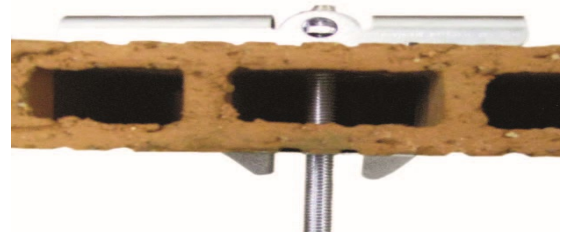

Ref.	Bar code EAN13	Artikel-Article		
A220028	3509092200284	Rondelle Rapid M6	100	
A220024	3509092200246	Rondelle "Rapid" M6 + Kipanker-Bascule	50	
			<b>Zakje- Sachet</b>	
A853540	3509098535403	Rondelle "Rapid" M6 + Kipanker-Bascule	10	10
<b>Koppelstuk Vrouwl. - Manl. M6-M8 - Raccord de jonction femelle - mâle</b>				

M8



M6

A140326	M6-M8 15mm	3509091403266	Koppelstuk-Raccord M6 F-V → M8 M	100	
				<b>Zakje- Sachet</b>	
A140324	M6-M8 15mm	3509091403242	Koppelstuk-Raccord M6 F-V → M8 M	10	10



A503340	M8-30mm	3509095033407	Tussenstuk-Entretoise M8 F-V	100	
---------	---------	---------------	------------------------------	-----	--

## Fix-Ring Elec®

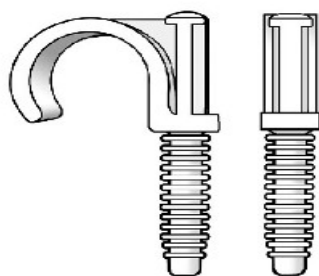

Boorgat Ø 6 mm - Perçage Ø 6 mm

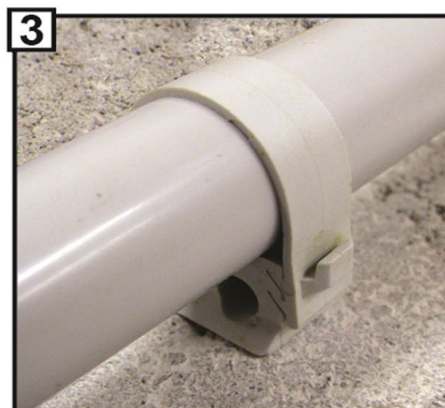
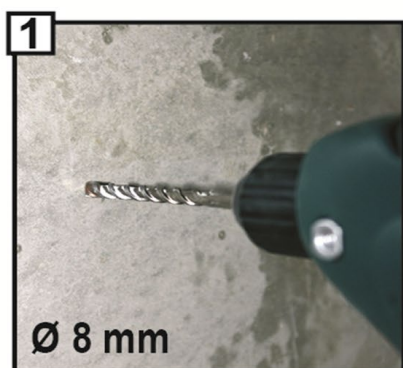
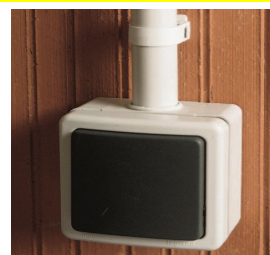

Ref.	Ø	Bar code EAN13	Artikel-Article		
A300020	16	3509093000203	Fix-Ring Elec Emmer - Seaux	100	24
A300025	20	3509093000258	Fix-Ring Elec Emmer - Seaux	100	24

## Fix-Ring +®



Bevestiging voor elektrische leidingen .Hulpstuk bij geleverd  
Sluiten & ontsluiten met schroevendraaier  
100%Nylon - Polyamide 6 - UV Bestendig - Brandwerend

Fixation de tubes électriques.Outil de pose fourni  
Fermé & ouvrir avec tournevis  
100% Nylon - Polyamide 6 - Stabilisé UV - Ignifugé

Ref.	Ø	Bar code EAN13	Artikel-Article		
S011000	16	3509090110004	Fix-Ring +	100	16
S011100	20	3509090111001	Fix-Ring +	100	16
S011200	25	3509090112008	Fix-Ring +	75	12

## Mini-Ring

Snel en gemakkelijke plaatsing voor coaxiale , TV antenne ,Telefoon en Glasvezel kabels etc...  
Boorgat Ø6 mm

Facile et placement rapide pour câbles coaxiaux ,antenne TV, fibre optique,Téléphone etc...  
Perçage Ø6



Verpakking-Embalage

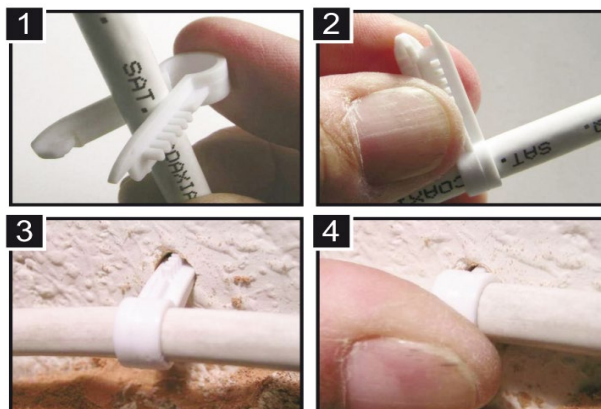

Ref.	Ø mm	Bar code EAN13	Artikel-Article		
4600055WH	5-6	5425003483011	Wit-Blanc kabel-cables 5-6mm	100	11
4600055BL	5-6	5425003483028	Zwart-Noir kabel-cables 5-6mm	100	11
4600066WH	6,2 - 7,2	5425003483035	Wit-Blanc kabel-cables 6,2-7,2mm	100	11
4600066BL	6,2 - 7,2	5425003483042	Zwart-Noir kabel-cables 6,2-7,2mm	100	11
4600100WH	9,8 - 10,7	5425003483059	Wit-Blanc kabel-cables 9,8-10,7mm	100	11
4600100BL	9,8 - 10,7	5425003483066	Zwart-Noir kabel-cables 9,8-10,7mm	100	11
4600130WH	13X7	5425003483073	Wit-Blanc kabel-cables 13X7mm	100	11
4600130BL	13X7	5425003483080	Zwart-Noir kabel-cables 13X7mm	100	11

## Fix-Tub Elec



Klembeugel breedte 7,5 mm - Collier largeur 7,5 mm.  
100% nylon polyamide 6 - 100 % nylon polyamide 6.  
Kleur grijs - Couleur grise.  
Snel en eenvoudig: met de hand aantrekken .  
Facile et rapide : serrage à la main.  
UV gestabiliseerd - Stabilisé UV.

**NEW**

Ref.	Ø mm	Bar code EAN13	Artikel-Article		
A322013	16-32	3509093220137	Fix-Tub Elec Doos-Boîte		100
A322016	16-32	3509093220168	Fix-Tub Elec Emmer-Seaux		200

# Fast-Ring®

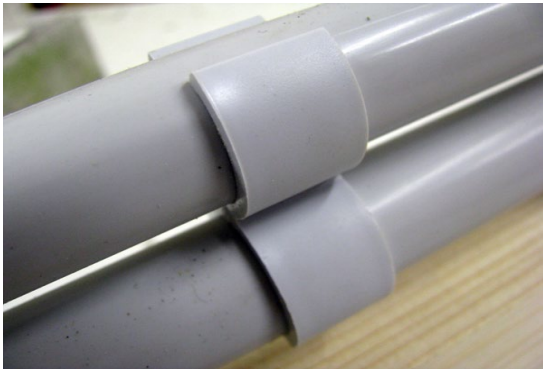

**Nylon PA6 Brandwerend (vrij van halogeen en rode fosfor) Zelfdovend:  
UL94-V0 UV Bestendig**

**Nylon PA6 Ignifugé (sans halogène et phosphore rouge) Auto-extinguible:  
UL94-V0 Stabilisé UV**

**Fast-Ring: voor het toevoegen aan bestaande buis met een Clic**  
**Fast-Ring: pour rajouter à un tube existant en un seul Clic**

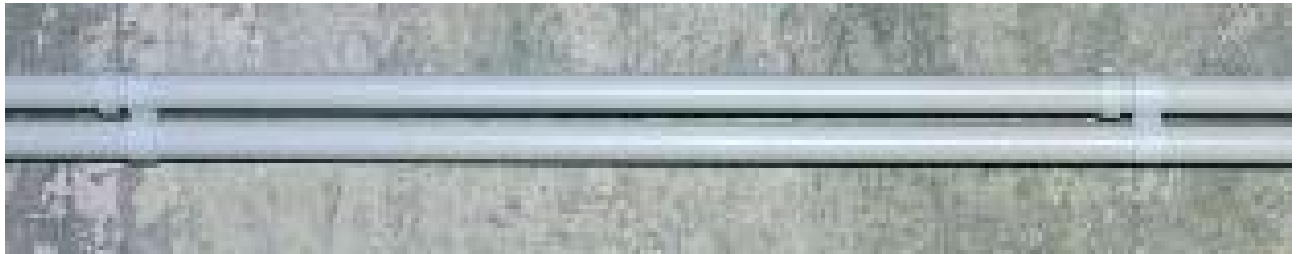

Ref.	Ø	Bar code EAN13	Artikel-Article		
S300500	16X16	3509093121007	Fast-Ring	100	16
S300550	20X20	3509093121502	Fast-Ring	100	16

# Clou-Elec®

Voor het bevestigen in volle en holle materialen, van elektrische goten, rails, dakranden etc.... Polyamide 6, roest niet. Boorgat Ø 6 mm

Pour fixer dans matériaux plein et creux, des gouttes électrique, des rails, solin etc... Polyamide 6, ne rouille pas, Perçage Ø 6 mm

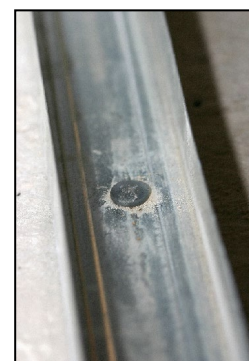
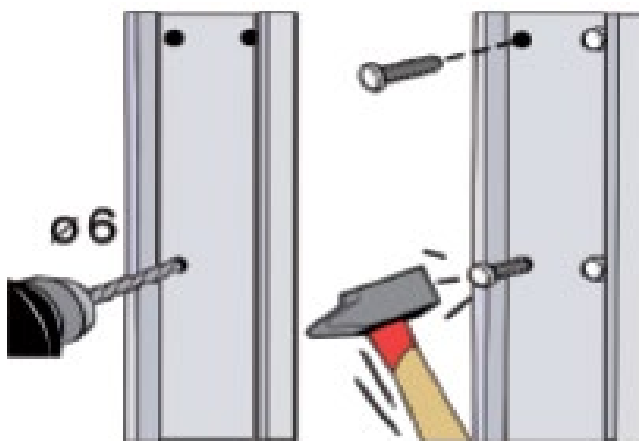

**Vermijd Thermische brug - Evite les ponts Thermiques**



Ref.	Ø	Bar code EAN13	Artikel-Article		
V101030	6	3509092695004	Clou-Elec <b>Wit-Blanc</b> Polyamide 6	300	12
V104020	6	3509092709305	Fix-Rail <b>Grijs-Gris</b> Polyamide 6	300	12

# Fix-Elec®

Vergemakkelijk het plaatsen van kleine goten  
Voor het bevestigen in volle en holle materialen Ø boorgat: 5mm  
Te gebruiken met schroevendraaier N°08 4X100

Facilite la pose des petites goulottes  
Fixation matériaux plein et creux Ø de perçage: 5mm  
à utiliser avec tournevis plat N° 08 4X100



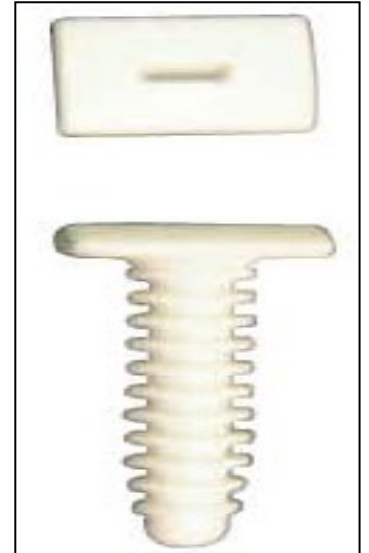
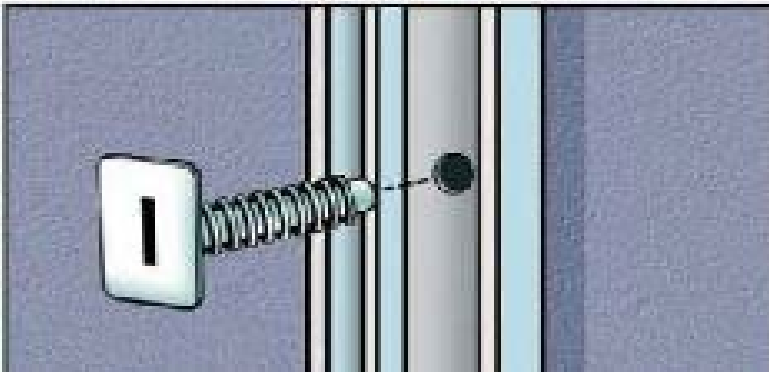
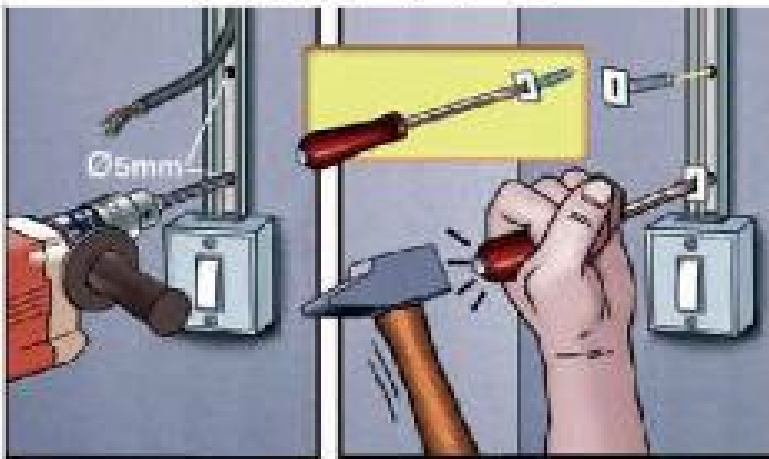

## FIX-ELEC





100% Nylon

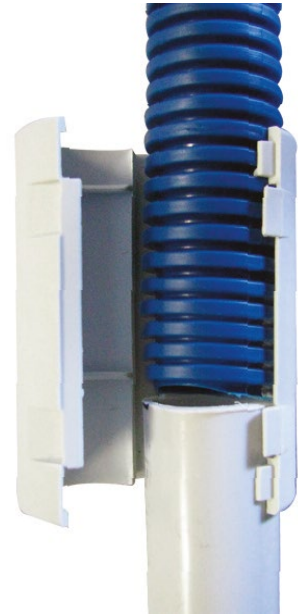
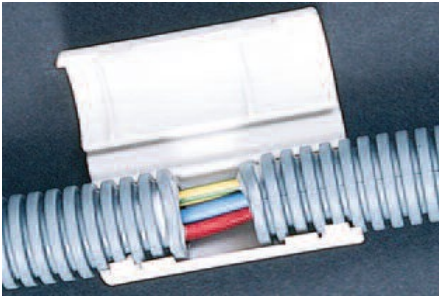

Ref.	Ø	Bar code EAN13	Artikel-Article		
V101000	5	3509092690009	Fix-Elec emmer-seau	500	12
V101012	5	3509091010129	Fix-Elec Plastique Doos-Boîte Plastique	200	11

## Connect-Ring®



Ref.	Ø	Bar code EAN13	Artikel-Article		
T040000	16	3509093201006	Connect-Ring	50	16
T040100	20	3509093202003	Connect-Ring	50	16
T040200	25	3509093203000	Connect-Ring	40	16

## Eco-Ring®

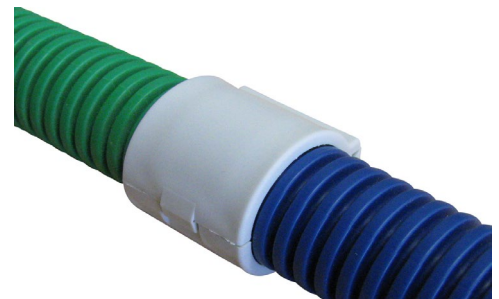
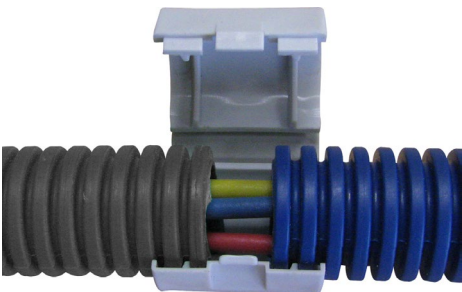

Ref.	Ø	Bar code EAN13	Artikel-Article		
T200010	16	3509093200108	Eco-Ring	100	12
T200020	20	3509093200207	Eco-Ring	100	12



# SPEEDY-FIX®

**Om rechtstreeks in beton te vijzen zonder plug, ook mogelijk in hout.  
In andere materialen (snelbouwers, bakstenen, etc.,) gebruik een plug.**

**Vissé directement dans le béton, sans cheville. Egalement possible dans le bois.**

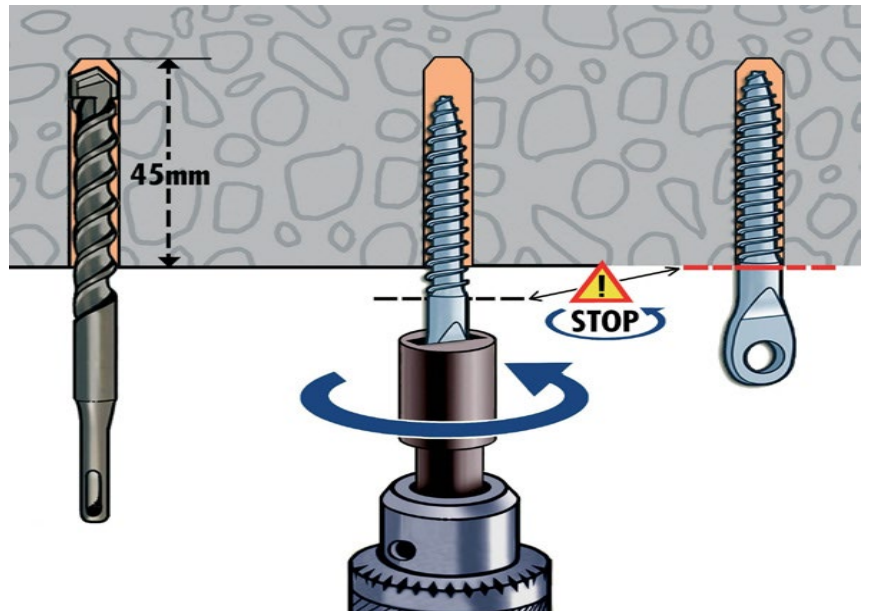
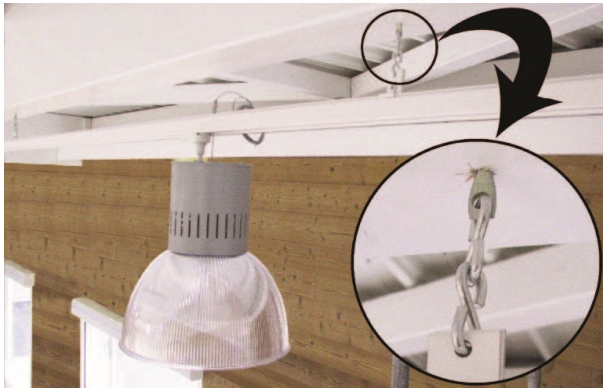

**Pour d'autres matériaux (Terca, briques, etc.,) employé une cheville.**



Ø 5 mm

***In iedere verpakking een hulpstuk voor plaatsing.  
Un outil de pose dans chaque emballage.***



Ref.	Ø	Bar code EAN13	Artikel-Article		
A858850	5	3509098588508	Speedy-Fix Plastik Doos-Boîte Plastique	11	11
A270355		3509092703556	Hulpstuk-Outil de pose	1	1

# Fix-Suspent®

**Om rechtstreeks in beton te vijzen ,zonder plug**  
**Vis pour suspendre directement dans le béton,sans cheville**





**" M6 "**



***In iedere verpakking een hulpstuk voor plaatsing.***  
***Un outil de pose dans chaque emballage.***



Ref.	Ø	Bar code EAN13	Artikel-Article		
V102110	5	3509092704102	Fix-Suspent Plastiek Doos-Boîte Plastique	50	11
V102120	5	3509092704201	Fix-Suspent Plastiek Doos-Boîte Plastique M6	50	11
A270355		3509092703556	Hulpstuk-Outil de pose	1	1

# FIX-ASPHALTE

## DEMONTTEERBARE BEVESTIGING MET HARS VOOR ASPHALT FIXATION DÉMONTABLE À LA RÉSINE POUR L'ASPHALTE

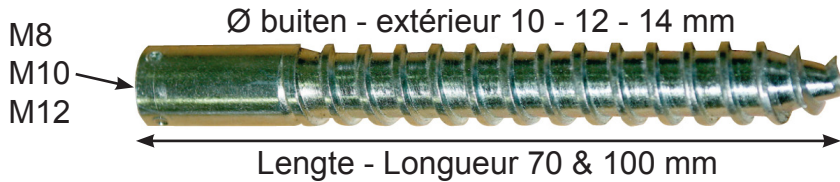

Omschrijving Désignation	Réf	Verp. Cond.	Afwerking Finition
M8 - Ø 10 x 70	A273805	20	Verzinkt - Zinguée
M10 - Ø 12 x 70	A273810	20	Verzinkt - Zinguée
M10 - Ø 12 x 100	A273820	20	Verzinkt - Zinguée
M12 - Ø 14 x 70	A273840	20	Verzinkt - Zinguée
M12 - Ø 14 x 100	A273850	20	Verzinkt - Zinguée

Richtwaarden breukbelasting (in kg)  
Charges indicatives de rupture (en kg)

Lengte Longueur	Tractie Traction	Schuiflast Cisaillement
70 mm	1000	800
100 mm	1800	800

### UITVOERING MISE EN OEUVRE

M8 : Boring - Perçage : 12 mm  
M10 : Boring - Perçage : 14 mm  
M12 : Boring - Perçage : 16 mm

**Te gebruiken met onze hars MP+  
Vinylester zonder styreen  
A utiliser avec notre résine MP+  
Vinylester sans styrène**



# Fix-Asphalte®

## Demonteerbare bevestiging met hars voor asphalt

Het is een economische, snel en doeltreffende bevestiging voor verschillende toepassingen.

## Fixations démontable à la résine pour asphalt

C'est une fixation économique, rapide, efficace avec de multiples utilisations pour différentes professions.

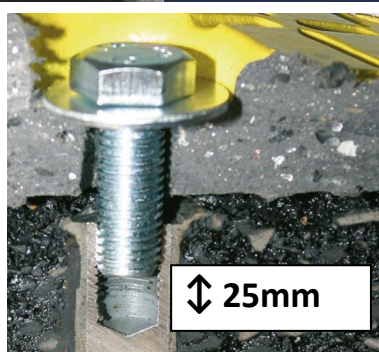
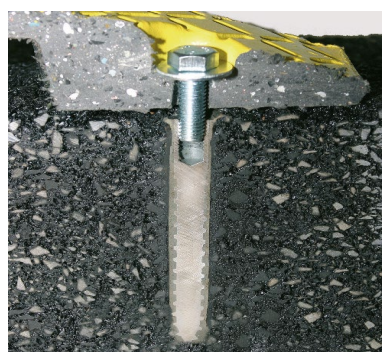



Boring-Perçage Ø 12 voor-pour M8

Boring-Perçage Ø 14 voor-pour M10

Boring-Perçage Ø 16 voor-pour M12

Boorgat reinigen met blaaspomp-Nettoyage du trou avec pompe soufflante

Ref.	Bar code	Artikel-Article		
EAN13				
A860003	M8 10x70 3509098600033	4x Fix-Asphalte + 4x Doppen-Cache M8	4	20
A860005	M10 12x70 3509098600057	4x Fix-Asphalte + 4x Doppen-Cache M10	4	20
A860006	M10 12x100 3509098600040	4x Fix-Asphalte + 4x Doppen-Cache M10	4	20
V105028	M12 14x70 3509091050286	4x Fix-Asphalte + 4x Doppen-Cache M12	4	20
A860007	M12 14x100 3509098600071	4x Fix-Asphalte + 4x Doppen-Cache M12	4	20
A273805	M8 10x70 3509092738053	20x Fix-Asphalte + 20xDoppen-Cache M8	20	
A273810	M10 12x70 3509092738107	20x Fix-Asphalte + 20xDoppen-Cache M10	20	
A273820	M10 12x100 '3509092738206	20x Fix-Asphalte + 20xDoppen-Cache M10	20	
A273840	M12 14x70 3509092738404	20x Fix-Asphalte + 20xDoppen-Cache M12	20	
A273850	M12 14x100 3509092738503	20x Fix-Asphalte + 20xDoppen-Cache M12	20	
A859830	3509098599309	Hars 300ml MP+ 2 mengdoppen 300ml MP+ embouts mélangeur	Résine 1	5

# FIXALU M6 & M8

Voor verankering op dunne metalen wanden  
Pour ancrages sur parois métalliques fines

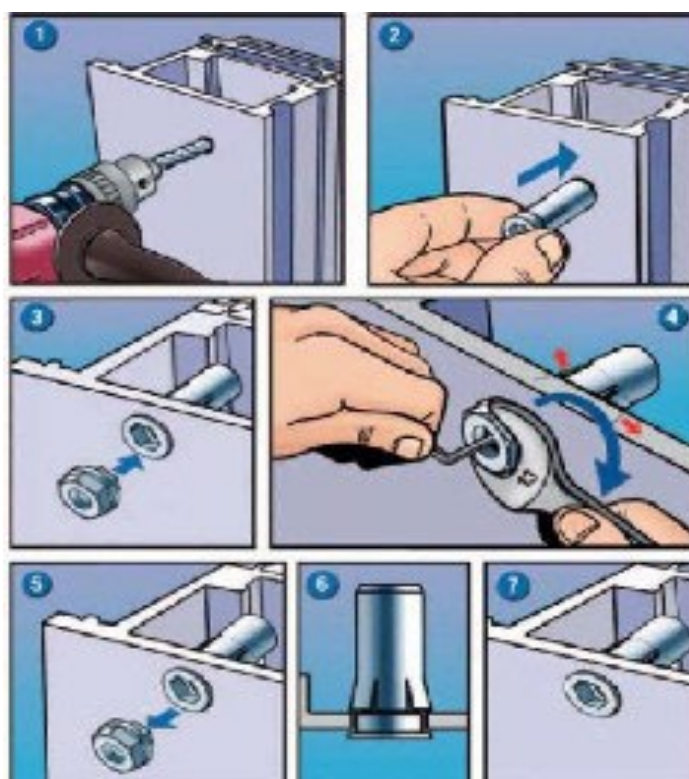
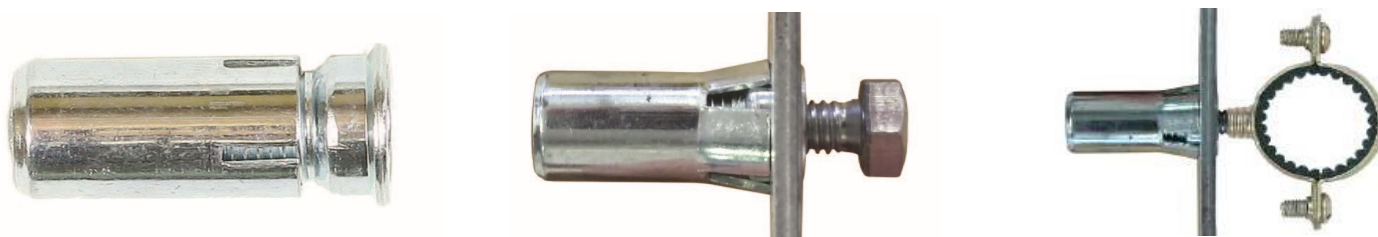

M6 Ø de perçage-boorgat 12,5mm Pou tôle de 1 à 3mm-Voor plaat van 1 tot 3 mm  
M8 Ø de perçage-boorgat 14,5mm Pou tôle de 1 à 3mm-Voor plaat van 1 tot 3 mm

Ref.	Ø	Bar code EAN13	Artikel-Article		
A140270	M6	3509091402702	Fixalu M6 Plastiek Doos-Boîte Plastique	30	11
A140280	M8	3509091402801	Fixalu M8 Plastiek Doos-Boîte Plastique	15	11



Ref.	Ø	Bar code EAN13	Artikel-Article		
34A640012501	12,5mm	9002741211852	HSS Boor met gereduceerde start Ø9,5	1	10
34A640014501	14,5mm	9002741211883	HSS Mèche avec queue réduite Ø9,5	1	8

# ISOLATIEPLUGGEN

# CHEVILLES POUR ISOLANTS

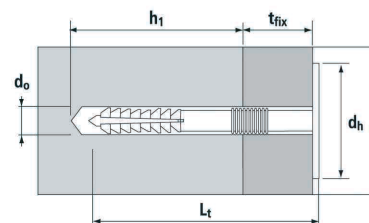
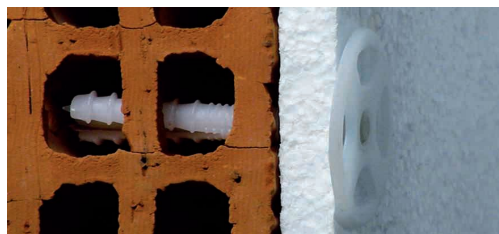
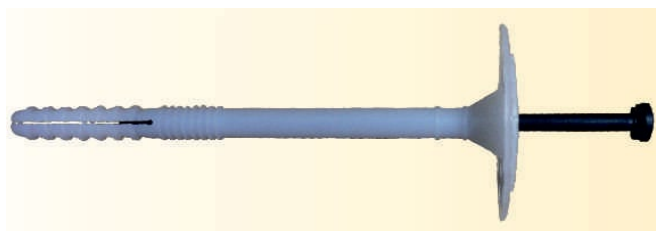

Prolypropyleen met nylon(PA6) pin met 30% Glasvezel

Prolypropylène avec axe en nylon (PA6) contenant 30% de fibre de verre

Ref.	Ø - L	Bar code EAN13	h1	dh	tfix	
31B10090	10/090	5425003482090	40-50	50	40-50	300
31B10110	10/110	5425003482113	40-50	50	60-70	300
31B10130	10/130	5425003482137	40-50	50	80-90	250
31B10150	10/150	5425003482168	40-50	60	100-110	250
31B10180	10/180	5425003482182	40-50	60	130-140	200
31B10210	10/210	5425003482199	40-50	60	160-170	100
31B10240	10/240	5425003482212	40-50	60	190-200	100

**Isol-Fix®**

**bevestiging voor afdichtingselementen**

**fixation d'éléments d'étanchéité**

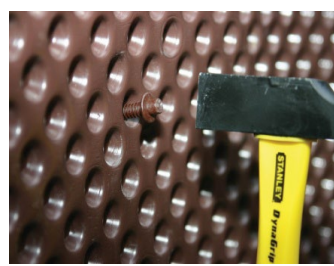
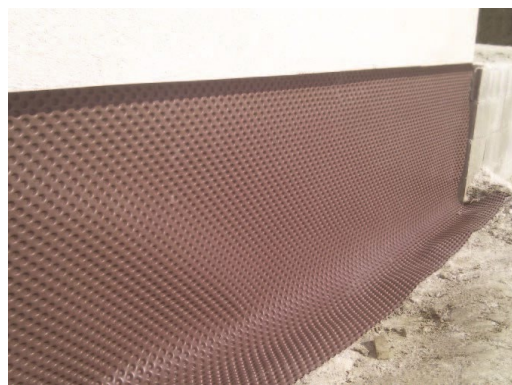

Ref.	Ø	Bar code EAN13	Artikel-Article		
V100010	6	3509091000106	Isol-Fix Emmer-Seau	370	12

# Debris Gully Q3

Regenwater afvoer van goten met puin opvangnet  
Drainage d'eau de pluie de gouttières avec receveur de débris

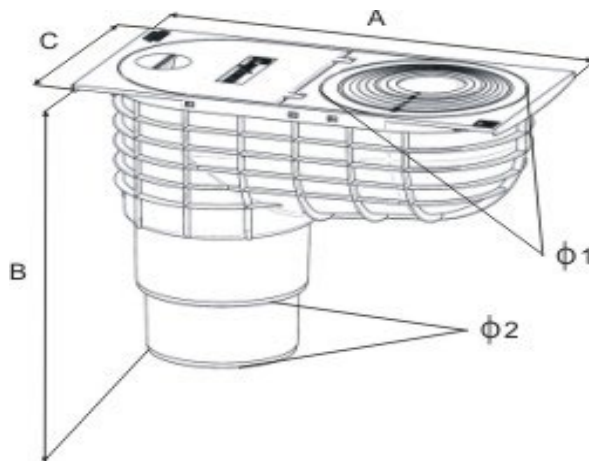

A: 325mm  
B: 259mm  
C: 160mm

Ø 1 50-125mm  
Ø 2 110-125mm

Polypropylene UV-Bestendig  
Stabilisé-UV

Ref.

Bar code EAN13

Artikel-Article



35C0010

5425003480102

Puin opvanger met korf  
Receveur de débris avec panier

1

6

## Terugslagklep 1 klep Clapet anti-retour 1 clapet

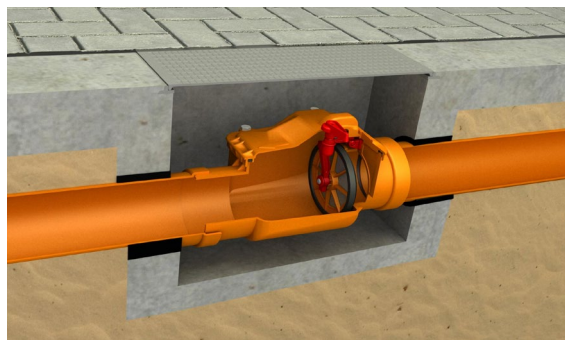



Ref.	Ø	Bar code EAN13	Artikel-Article	
35C5000110	110	5906485921708	Terugslagklep 1 klep-Clapet anti-retour 1 clapet	1
35C5000125	125	5903083062390	Terugslagklep 1 klep-Clapet anti-retour 1 clapet	1
35C5000160	160	5906485922446	Terugslagklep 1 klep-Clapet anti-retour 1 clapet	1
35C5000200	200	5906485927311	Terugslagklep 1 klep-Clapet anti-retour 1 clapet	1

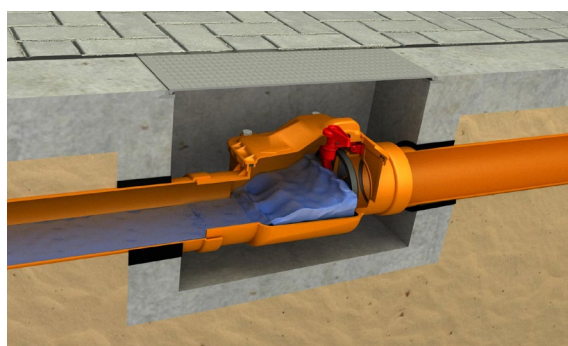

35C5000050	50	5906485923177	Terugslagklep 1 klep-Clapet anti-retour 1 clapet	1
35C5010050	50	5906485924655	Terugslagklep 1 klep met verticale uitgang Clapet anti-retour 1 clapet avec sortie vertical	1

## Terugslagklep 2 kleppen Clapet anti-retour 2 clapets



Ref.	Ø	Bar code EAN13	Artikel-Article	
35C5020110	110	5900308306413	Terugslagklep 2 kleppen-Clapet anti-retour 2 clapets	1
35C5020125	125	5900308306383	Terugslagklep 2 kleppen-Clapet anti-retour 2 clapets	1
35C5020160	160	5906485925225	Terugslagklep 2 kleppen-Clapet anti-retour 2 clapets	1
35C5020200	200	5906485925249	Terugslagklep 2 kleppen-Clapet anti-retour 2 clapets	1



# Afvoer Vloergoten-Caniveaux de drainage extérieur

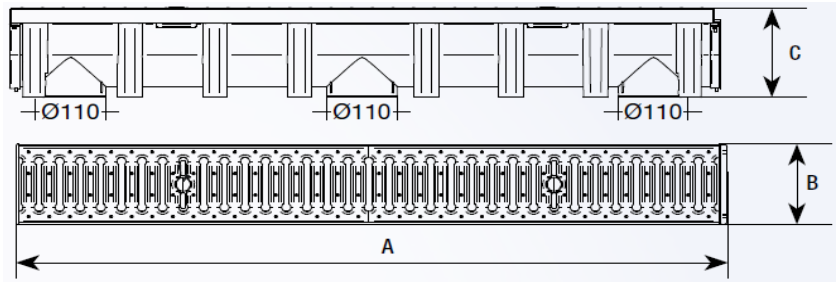
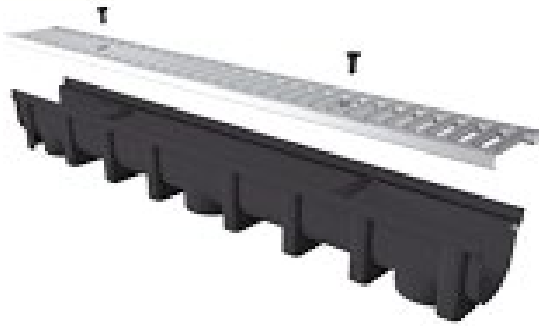

Ref.	Ø	A	B	C	Artikel-Article	
35C9101110	110	1000 x 127 x 141			Vloergoten-Caniveaux	1



Ref.	Ø	A	B	C	Artikel-Article	
35C9103141	110				Stop - Bouchon	10



Ref.	Ø	A	B	C	Artikel-Article	
35C9102110	110				Aansluiting - Raccordement	10



Ref.	Ø	A	B	C	Artikel-Article	
35C9104110	110	1000 x 127 x 141			Kit Vloergoten 3 stuks + 1 Stop + 1 Aansluiting	1
		5900308330838			Kit Caniveaux 3 pièces + 1 Bouchon + 1 Raccordement	

**Stevige professionele pistool voor silicone & chemische bevestiging**  
**Pistolet professionnel robuste pour silicone & encrage chimique**



Ref.	Bar code EAN13	Artikel-Article		
A040055	3509090400556	Pistool-Pistolet SUPER PRO 300 ml	1	24



Ref.	Bar code EAN13	Artikel-Article		
A040095	3509090400952	Pistool-Pistolet PRO 380ml-410ml	1	24

**Blaaspomp - Pompe soufflante**



Ref.	Bar code EAN13	Artikel-Article		
A030040	3509090300405	Blaaspomp - Pompe soufflante	1	24

## Automatische Pijpsnijder Coupe Tube Automatique



Vervang wieltje  
Roulette de rechange



Nieuwe methode  
Nouvelle méthode



Traditionele manier  
Méthode traditionnelle



Display

Ref.	Ø	Bar code EAN13	Artikel-Article		
42H0330	3-30mm	5425003483301	Speedycut	1	12

# AryKneeFlex

Certified EN14404 + A1 2010



#### MULTIFUNCTIONEEL:

aannemers bouw, elektriciteit,  
tegelwerk, schrijnwerker, tuinaanlag,  
industrie, renovatie, onderhoud,  
metselwerken, schilderwerken,  
loodgieterij, dakdekker, enz...

#### MULTIFONCTIONNEL:

entreprise de bâtiments, électricité,  
carrelage, menuiserie, jardinage,  
industrie, rénovation, entretien,  
maçonnerie, peintre en bâtiments,  
plomberie, couvreur, etc...

Ref.	Bar code EAN13	Artikel-Article		
AK00100	5425003480010	Ary Knee Flex <b>LichtGrey</b>	1	24
AK00200	5425003480027	Ary Knee Flex <b>Darkgrey</b>	1	24

Kniebeschermer met gewricht, zeer stevig, isolerend, regelbaar en niet-markerende ANTI SLIP STRIP met agressief profiel en Soft profiel . Verwisselbaar. 2 sets inbegrepen!

Genouillère articulaire très résistante, munie d'isolation ,réglable et avec ANTI SLIP STRIP anti-trace avec un profil agressif et un profil Soft .Interchangeable. 2 jeux inclus !



## KNEE RX #950 KNEE RX HD #951

- Knie bescherming ontworpen voor een duurzaam comfort .
  - Aanbevelingen voor het gebruik op grind, asfalt, beton, hout en metaal.
  - PVC-schuim is ontworpen voor een hoge resistentie tegen olie en andere vetten.
  - 2,80 cm dik voor maximaal comfort
  - Stevige rubberen onderkant voor een langere levensduur. (# 951 Knie RX alleen HD).
  - Totale afwezigheid van siliconen, dit product is niet-geleidend, brandwerend, zelfdovend.
  - Geïntegreerd handvat, makkelijk mee te nemen of op te hangen.
- *Conçu pour un apporter un confort et une durée de vie extrême pour des applications à genoux.*
  - *Utilisation conseillée sur un sol en gravier, en asphalt, en béton, en bois et en metal.*
  - *Mousse de PVC conçu pour un degré de résistance accru contre les huiles et autres graisses.*
  - *2,80 cm d'épaisseur pour un confort maximum*
  - *Robuste surface inférieure en caoutchouc ajoutant une durée de vie prolongée. (#951 Knee RX HD only).*
  - *Absence totale de silicone, ce produit est non-conducteur. Pas de propagation de flamme, s'auto-éteint.*
  - *Poignée intégrée, facile à porter ou à suspendre.*

Ref.	Bar code EAN13	Artikel-Article	
N950S1222	5425003489501	Knee RX 55cm x 30cm x 28mm	1
N951S1222	5425003489525	Knee RX Heavy Duty 55cm x 30cm x 28mm	1
N951S0815	5425003489518	Knee RX Heavy Duty 38cm x 20cm x 28mm	1

# Schijf-Disque SPEEDY



**Voor het zagen van PVC,HOUT met een slijpschijf "op de werf"**  
**Pour couper le PVC,BOIS à l'aide d'une meuleuse "sur chantier"**

Ref.

Bar code

Artikel-Article



EAN13

A105020

3509091050200

Schijf - Disque Ø 125

1

# Abrasifs-Abrasives



# Doorslijpschijven "POWER SLIT" Disques de tronçonnage "POWER SLIT"



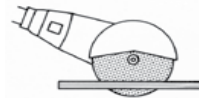

POWER-producten zijn gemaakt van de beste grondstoffen van Europese oorsprong.  
Les produits POWER sont fabriqués à partir des meilleures matières premières d'origine européenne.



Mini Box

Norme EN 12413 Toepassing : **Ijzer-Staal & Inox**

Applications : **Fer-Acier & Acier Inox**

Ref.				
M100010●	115 x 1,0 x 22,23	8032646100587	Power SLIT	25
MB100010●	115 x 1,0 x 22,23	5425003481154	Metaal doos-Boîte Métallique	10
MB100012●	115 x 1,0 x 22,23		Mini Box X 10 M.Dozen-Boîtes M.	10
M100015	115 x 1,6 x 22,23	8032646100594	Power SLIT	25
M100020●	125 x 1,0 x 22,23	8032646101003	Power SLIT	25
MB100020●	125 x 1,0 x 22,23	5425003481253	Metaal doos-Boîte Métallique	10
MB100022●	125 x 1,0 x 22,23		Mini Box 10 X M.Dozen-Boîtes M.	10
M100025●	125 x 1,6 x 22,23	8056300871026	Power SLIT	25
M100030●	230 x 1,9 x 22,23	8032646100853	Power SLIT	25

# Lamellenschijven Disques à lamelles

LAMELENSCHIJVEN POWER GEBOGEN MET ZIRCONIUM

DISQUES À LAMELLES POWER BOMBÉ AU ZIRCONIUM



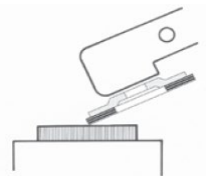
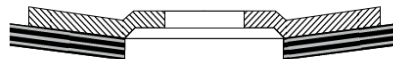

Norme EN 13743



Toepassing : **Ijzer-Staal-Inox-Gietijzer-Aluminium**

Applications : **Fer-Acier-Inox-Fonte-Aluminium**

Ref.			Korrel-Grain	
M100110●	115 x 22,23	8032646105964	ZZ040S	10
M100112●	115 x 22,23	8032646105988	ZZ060S	10
M100114	115 x 22,23	8032646106008	ZZ080S	10
M100120●	125 x 22,23	8032646106046	ZZ040S	10
M100122●	125 x 22,23	8032646106060	ZZ060S	10
M100124●	125 x 22,23	8032646106084	ZZ080S	10

● in voorraad-en stock



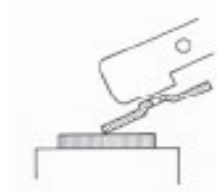
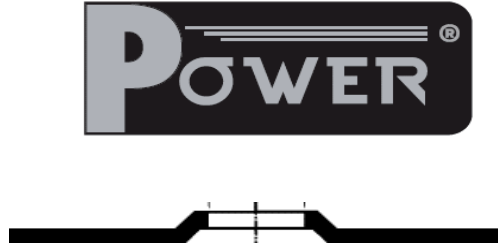

# Ontbraamschijven "POWER GRIND" Disques d'ébarbage "POWER GRIND"



Toepassing : **Ijzer-Staal & Inox**

Applications : **Fer-Acier & Acier Inox**

Ref.				
M100090	115 x 7,0 x 22,23	8032646101614	Power GRIND	10
M100092●	125 x 7,0 x 22,23	8032646101669	Power GRIND	10

# Lamellenschijven Disques à lamelles

DUBBELE KERAMISCHE GEBOGEN LAMELENSCHIJVEN MET ZIRKONIUM

DISQUES À LAMELLES DOUBLE TOILE CERAMIQUE BOMBÉ AU ZIRCONIUM



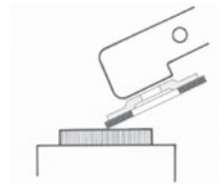
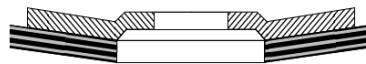

Norme EN 13743



Toepassing : **Ijzer-Staal-Inox-Gietijzer-Aluminium**

Applications : **Fer-Acier-Inox-Fonte-Aluminium**

Ref.			Korrel-Grain	
M100150	115 x 22,23		ZZ040S	10
M100152	115 x 22,23		ZZ060S	10
M100154	115 x 22,23		ZZ080S	10
M100160●	125 x 22,23	8032646106794	ZZ040S	10
M100162●	125 x 22,23	8032646106800	ZZ060S	10
M100164●	125 x 22,23	8032646106817	ZZ080S	10

● in voorraad-en stock



# Premium



Seg.Laser gelast / Seg.Soudure Laser

## KLSS

Toepassing : Beton(gewapend),Baksteen,Stenen,Granit.

Applications : Béton(armé),Pierres Rouge,Pierres,Granit.



Code-Kode  
Codice

Ø



Z



Code-Kode Codice	Ø	Thickness	Z	Barcode
E73P125C ●	125	2,2	10	8024788005615
E73P230C ●	230	2,6	16	8024788005653

# Standard



Seg.Laser gelast / Seg.Soudure Laser

## PWL

Toepassing : Beton,Baksteen,Stenen.

Applications : Béton,Pierres Rouge,Pierres.



Code-Kode  
Codice

Ø



Z



Code-Kode Codice	Ø	Thickness	Z	Barcode
E71P115C ●	115	2,2	9	8024788000849
E71P125C ●	125	2,2	10	8024788000566
E71P230C ●	230	2,6	16	8024788000856

# Economy



Gesinterde Segmenten / Segements Jonction par frittage

## UWS

Toepassing : Beton,Baksteen.

Applications : Béton,Briques.



Code-Kode  
Codice

Ø



Z



Code-Kode Codice	Ø	Thickness	Z	Barcode
E69X115C ●	115	2,2	8	8024788004991
E69X125C ●	125	2,2	9	8024788004472
E69X230C ●	230	2,5	16	8024788004984

De referenties met ● zijn in voorraad  
Les références avec ● sont en stock.

07-2023  
059

**anymex**

# Professional



Vacuum Technik / Technologie sous vide

## MTM

Toepassing : Alle materialen (Vooral voor PVC buizen)

Applications : Tous les matériaux (Surtout pour tuyaux PVC)



Code-Kode

Codice

Ø



Code-Kode	Codice	Ø	
Y422115A0C		115	8024788009118
Y422125A0C	•	125	8024788009125
Y422230A0C	•	230	8024788009149

# Premium



Seg.Laser gelast / Seg.Soudure Laser

## HMT

Toepassing : Metaal,Beton(gewapend),Spanbeton,Asfalt.

Applications : Fer,Béton(armé),Béton précontraint,Asphalt.

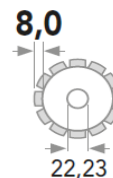

Code-Kode

Codice

Ø



Z



Code-Kode	Codice	Ø		Z	
E24P125C	•	125	2,2	11	8024788000931
E24P230C	•	230	2,6	16	8024788000917

SPECIALE SEGMENTEN uitgevoerd met legering en diamanten geschikt voor metaal te snijden.

SEGMENTS SPECIAUX réalisés avec alliages et diamants aptes à couper aussi le fer.

STAAL MET BORINGEN voor afkoeling van de schijf en zo het pauzeren te vermijden.

ACIER TROUE pour refroidir le disque afin d'éviter les pauses.

De referenties met • zijn in voorraad

Les références avec • sont en stock.

07-2023  
060

**anymex**

# Special



Seg.Laser gelast / Seg.Soudure Laser

## QNBL

Toepassing : Beton(gewapend),Granit,Gesteente.

Applications : Béton(armé),Granit,Pierres.



Code-Kode  
Codice

Ø



Z



€

E39Q2300C •	230	2,4	16	8024788007589
-------------	-----	-----	----	---------------



**SPECIALE SEGMENTEN** met een precieze geometrische verdeling van de diamanten.Deze verdeling bepaalt een exacte blootselling van een aantal voorbestemde korrels en verzekert een constante voor een snellere doorsnijding en langere levensduur.

**SEGMENTS SPECIAUX** avec la distribution des diamants selon un plan géométrique précis.

Cette distribution détermine l'exacte exposition d'un nombre prédéterminé de grains et assure la constante pour une coupe plus rapide et une durée de vie plus longue.

# Special



Volleband Kroon / Couronne Continue

## SK9 SILENT

Toepassing : Beton(gewapend),Granit,Gesteente.

Applications : Béton(armé),Granit,Pierres.



Code-Kode  
Codice

Ø

Borr.Alés.

Bohr.Foro

X



E3808230 •	230	22,2	9	8024788008005
------------	-----	------	---	---------------

**DUBBELE KROON** met verschillende dikte voor minder weerstand.

**ONDERBROKEN KROON** met laser gesneden,voor thermische compensatie van kroon.

**STAAL MET BORINGEN** voor afkoeling van de schijf en zo het pauzeren te vermijden.

**COURONNE INTERROMPUE** avec coupes laser pour compenser l'expansion thermique de la couronne diamantée dans des applications lourde.

**DOUBLE COURONNE** avec épaisseurs différentes pour réduire l'effort de la friction laterale.

**ACIER TROUE** pour refroidir le disque afin d'éviter les pauses continues.



De referenties met • zijn in voorraad

Les références avec • sont en stock.

07-2023  
061

**anymex**

## Premium

Volleband Kroon / Couronne Continue



### CUS-K

Toepassing : GRES GEGLAZUURD(Zandsteen),HARDE KERAMIEK.

Applications : GRES EMAILLE, KLINKER, CERAMIQUE DURE.



Code-Kode  
Codice

Ø



Code-Kode Codice	Ø		
E47K115C	115	1,4	8024788005059
E47K125C ●	125	1,6	8024788005066

FIJNE SCHIJF met onderbroken kroon,laser gesneden met centrale versterking,voor de stabiliteit en de geruisloosheid.

DISQUE FIN avec couronne interrompue avec coupe laser et renforcement central, pour le rendre plus résistant, stable et silencieux

### CUS-S

Toepassing : GRES GEGLAZUURD(Zandsteen),HARDE KERAMIEK.

Applications : GRES EMAILLE, KLINKER, CERAMIQUE DURE.



Code-Kode  
Codice

Ø



Code-Kode Codice	Ø		
E490125C ●	125	1,6	8024788002591
E490230C ●	230	2,0	8024788000726

## Professional

Volleband Kroon / Couronne Continue



### CWA

Toepassing : GRES GEGLAZUURD(Zandsteen), KERAMIEK.

Applications : GRES EMAILLE, KLINKER, CERAMIQUE .



Code-Kode  
Codice

Ø



Code-Kode Codice	Ø		
E510115C	115	1,4	8024788000894
E510125C ●	125	1,6	8024788000979
E510230C ●	230	2	8024788000986

## Economy

Volleband Kroon / Couronne Continue



### CWC

Toepassing : KERAMIEK.

Applications : CERAMIQUE .



Code-Kode  
Codice

Ø

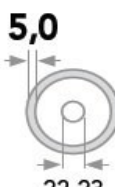

Code-Kode Codice	Ø		
E700115C ●	115	1,6	8024788004885
E700125C ●	125	1,6	8024788005226

De referenties met ● zijn in voorraad

Les références avec ● sont en stock.

07-2023  
062

**anymex**

# Diamant schijven voor Gleufmachine Disques Diamantés pour Rainureuses

## Professional

Seg.Laser gelast / Seg.Soudure Laser



### SCT

Toepassing : Beton(gewapend),Baksteen.

Applications : Béton(armé),Briques.



Code-Kode

Codice

Ø



Z



Code-Kode	Codice	Ø	Z	Barcode	
E54P125C	•	125	2,2	10	8024788006797

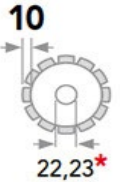

SEGMENTEN MET ZIJDELINGSE GROEVEN voor een betere afvoer van de materialen.  
SEGMENTS AVEC RAINURE LATERALE pour permettre l'évacuation des matériaux.

## Premium

Seg.Laser gelast / Seg.Soudure Laser



### SCC

Toepassing : Beton(gewapend),Baksteen.

Applications : Béton(armé),Briques.



Code-Kode

Codice

Ø



Z



Code-Kode	Codice	Ø	Z	Barcode	
E52P125C	•	125	2,2	10	8024788003185
E52P140C	•	140	2,3	11	8024788003192
E52P150C	•	150	2,4	12	8024788001358
E52P180C	•	180	2,4	14	8024788001365
E52P230C		230	2,4	16	8024788003222

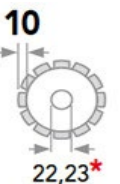

De referenties met • zijn in voorraad

Les références avec • sont en stock.

07-2023  
063

**anymex**

# Slijpschijven droog gebruik voor haakse slijpmachine

## Meules segmentées et Couronne continue

### Professional



Segmenteerde Dubbele Kroon / Segmentées double Couronne

### MSC

Toepassing : Beton,Baksteen,Stenen.

Applications : Béton,Pierres Rouge,Pierres.

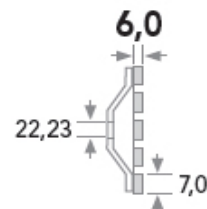

Code-Kode

Codice

Ø

Z



E851125C	•	125	10+10	8024788006643
E851180C	•	180	12+12	8024788002102

### Standard



Volleband Kroon / Couronne Continue

### MCD

Toepassing : Beton,Granit,Gesteente.

Applications : Béton,Granit,Pierres.

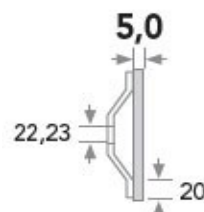

Code-Kode

Codice

Ø



E857100C	•	100		8024788006698
E857125C	•	125		8024788006780

De referenties met • zijn in voorraad

Les références avec • sont en stock.

07-2023  
064

**anymex**



## Diamant schijven nat gebruik voor Tafelzagen Disques Diamantés coupe à eau pour Scies de table

### Premium



Volleband Kroon / Couronne Continue

#### MSU

Toepassing : GRES GEGLAZUURD(Zandsteen), HARDE KERAMIEK.

Applications : GRES EMAILLE, KLINKER, CERAMIQUE DURE.



Code-Kode  
Codice

Ø



Code-Kode Codice	Ø	Thickness	Barcode
E47D180E	180	1,6	8024788002515
E47D200E	200	2,0	8024788003963
E47D230E	230	2,0	8024788007442
E47D250E	250	2,0	8024788003970
E47D300E ●	300	2,2	8024788003987
E47D350E ●	350	2,2	8024788003994
E47D400E	400	2,4	8024788004007

### Professional



Volleband Kroon / Couronne Continue

#### MPU

Toepassing : GRES GEGLAZUURD(Zandsteen), KERAMIEK.

Applications : GRES EMAILLE, KLINKER, CERAMIQUE.



Code-Kode  
Codice

Ø



Code-Kode Codice	Ø	Thickness	Barcode
E370180E ●	180	1,6	8024788003376
E370200E	200	2,0	8024788001570
E370250E	250	2,0	8024788001594
E370300E ●	300	2,2	8024788001600
E370350E ●	350	2,2	8024788003390

### Standard



Volleband Kroon / Couronne Continue

#### MCU

Toepassing : Marber, Keramiek. / Applications : Marbre, Ceramique.

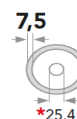

Code-Kode  
Codice

Ø



Code-Kode Codice	Ø	Thickness	Barcode
E360150E ●	150	1,6	8024788001488
E360180E ●	180	1,6	8024788001495
E360200E	200	2,0	8024788001501
E360230E	230	2,0	8024788001532
E360250E	250	2,0	8024788001525
E360300E	300	2,2	8024788001518
E360350E	350	2,2	8024788003352

De referenties met ● zijn in voorraad

Les références avec ● sont en stock.

07-2023  
065

# Special



Seg.Laser gelast / Seg.Soudure Laser

## QNBU

Toepassing : Beton,Granit,Gesteente,Abrasive materialen,vuurvast material.

Applications : Béton,Granit,Pierres,Pierres abrasives,Refractaires .



Code-Kode

Codice

Ø



Z

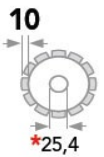

Code-Kode Codice	Ø	Thickness	Z	Barcode
E40P3001E	300R	3,0	20	8024788013962
E40P3501E	350R	3,0	24	8024788013979
E40P4001E	400R	3,0	28	8024788013986
E40Y4501E	450R	3,6	30	8024788009927
E40Y5001E	500R	3,6	32	8024788009958
E40Y6001E	600R	4,0	36	8024788009989

SPECIALE SEGMENTEN met een precieze geometrische verdeling van de diamanten.

SEGMENTS SPECIAUX avec la distribution des diamants selon un plan géométrique précis.

# Professional



Seg.Laser gelast / Seg.Soudure Laser

## CGSU

Toepassing : Beton,Vuurvaste stenen,Abrasive materialen.

Applications : Béton,Réfractaires,Pierres abrasives.



Code-Kode

Codice

Ø



Z

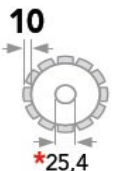

Code-Kode Codice	Ø	Thickness	Z	Barcode
E46P250	250R	2,8	18	8024788006001
E46P300 ●	300R	2,8	20	8024788006018
E46P350 ●	350R	3,0	24	8024788006025
E46P400	400R	3,2	28	8024788006032
E46P450	450R	3,6	32	8024788006049
E46P500	500R	3,6	36	8024788006056

## GSU

Toepassing : Granit,Gesteente,Harde stenen.

Applications : Granit,Briques,Pierres dures.



Code-Kode

Codice

Ø



Z

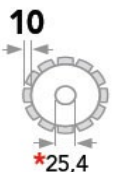

Code-Kode Codice	Ø	Thickness	Z	Barcode
E60P300 ●	300R	2,8	21	8024788014457
E60P350 ●	350R	3,0	25	8024788014464
E60P400	400R	3,2	28	8024788014471

Verkrijgbaar-Disponible Ø 450,500,550,600,650,700,720.

De referenties met ● zijn in voorraad

Les références avec ● sont en stock.

07-2023  
066

# Professional



Vacuum Technologie / Technologie sous vide

## FDA

Toepassing : GRES GEGLAZUURD(Zandsteen),GEBRANDE KERAMIEK,KERAMIEK,GRANIET,MARBER.  
Applications : GRES EMAILLE, CERAMIQUE MONOCUITE,CERAMIQUE,GRANIT,MARBRE.



**Nauwkeurig boren**  
**Perçage précis**

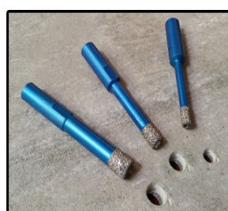

**Droogboren**  
**Perçage à sec**

Code-Kode  
Codice

Ø

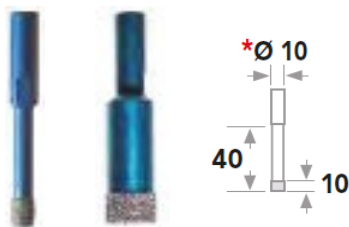

YF006A ●	6	2,0	8024788013702
YF008A ●	8	2,0	8024788013719
YF010A ●	10	2,2	8024788013726
YF012A ●	12	2,2	8024788013733
YF014A ●	14	2,2	8024788013740
YF016A ●	16	2,2	8024788013757



0BZA0 ●	4,6,8,10,12	Sjablone-Centreur	8024788014433
---------	-------------	-------------------	---------------



YF060810 ●	Kit Ø6-Ø8-Ø10 + Sjablone-Centreur	5425003488108
------------	-----------------------------------	---------------

De referenties met ● zijn in voorraad  
Les références avec ● sont en stock.

07-2023  
067

**arymex**

# Professional

Vacuum Technologie / Technologie sous vide

FDB

M14 F

Toepassing : GRES GEGLAZUURD(Zandsteen),GEBRANDE KERAMIEK,KERAMIEK,GRANIET,MARBER.

Applications : GRES EMAILLE, CERAMIQUE MONOCUITE,CERAMIQUE,GRANIT,MARBRE.

**Droogboren**  
**Perçage à sec**



Code-Kode  
Codice

Ø



Code-Kode Codice	Ø		
YF0060M ●	6	2,2	8024788010800
YF0080M ●	8	2,2	8024788010817
YF0100M ●	10	2,2	8024788010824
YF0120M	12	2,2	8024788010831
YF0140M	14	2,2	8024788010844
YF0200M ●	20	2,2	8024788010855
YF0270M ●	27	2,2	8024788010862
YF0300M ●	30	2,2	8024788010879
YF0350M ●	35	2,2	8024788010886
YF0400M	40	2,2	8024788010893
YF0450M	45	2,2	8024788010909
YF0500M ●	50	2,2	8024788010916
YF0600M	60	2,5	8024788010923
YF0650M ●	65	2,5	8024788010930
YF0700M	70	2,5	8024788010947
YF0750M	75	2,5	8024788010954

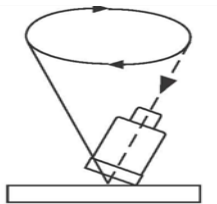
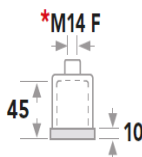
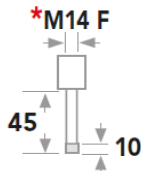

\* KROON MET MONOLAAG DIAMANT onder vacuüm.

\* COURONNE MONOCOUCHE DE DIAMANT lié en atmosphère contrôlée avec métaux fondus.

DE BORING SCHUIN STARTEN EN VERDER MET EEN DRAAIENDE BEWEGING.

COMMENCER LE PERÇAGE AVEC LE FORET INCLINE ET CONTINUER AVEC UN MOUVEMENT OSCILLANT.



120BB05 ● Adapter-Adaptateur Ø12 M14 M

8024788009255

De referenties met ● zijn in voorraad

Les références avec ● sont en stock.

07-2023  
068

**anymex**

# Professional

**Droogboren  
Perçage à sec**

Seg.Laser gelast / Seg.Soudure Laser



## FCS

KOPPELING / ACCOUPLEMENT / EINSATZ / ATTACCO : **M16 F**

LENGTE/ LONGUEUR / LÄNGE / LUNGHEZZA : **150 mm**

Toepassing : Beton, Baksteen.

Applications : Béton, Briques.

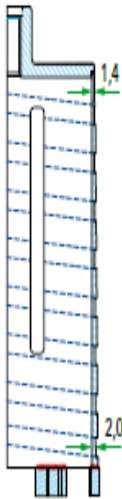
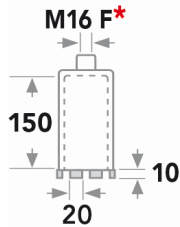

\*

Code-Kode

Codice

Ø

Z



Code-Kode Codice	Ø	Z		
E9300320 ●	32	3	3,2	8024788003505
E9300370	37	3	3,2	8024788003512
E9300420 ●	42	3	3,2	8024788003529
E9300520 ●	52	4	3,5	8024788003543
E9300570	57	4	3,5	8024788003550
E9300620 ●	62	4	3,5	8024788003567
E9300670 ●	67	4	3,5	8024788003574
E9300720 ●	72	4	3,5	8024788003710
E9300820 ●	82	5	3,5	8024788003598
E9300920 ●	92	5	3,5	8024788003727
E9301020 ●	102	6	3,5	8024788003611
E9301070 ●	107	6	3,5	8024788003604
E9301120 ●	112	6	3,5	8024788003628
E9301220	122	6	3,5	8024788003642
E9301270	127	6	3,5	8024788003635
E9301320 ●	132	6	3,5	8024788003659
E9301420	142	6	3,5	8024788003666
E9301520	152	7	3,5	8024788003680
E9301620	162	7	3,5	8024788003673
E9301820	182	8	3,8	8024788003697
E9302020	202	8	3,8	8024788003703

\* GROEVEN VOOR AFVOER VAN MATERIALEN- \* RAINURE POUR L'EVACUATION DES MATERIAUX

D3 G X K P Z R



Code-Kode	Type	Machine	Tool	
0BG05	D3	M18F	M16 M	
0BG00 ●	GO	Ø13 L100	M16 M	Zeskantig-six pands
0BG01 ●	G1	Ø13 L200	M16 M	Zeskantig-six pands
0BG02 ●	G2	Ø13 L300	M16 M	Zeskantig-six pands
0BX00 ●	X0	SDS+ L100	M16 M	SDS +
0BX01 ●	X1	SDS+ L200	M16 M	SDS +
0BX02 ●	X2	SDS+ L300	M16 M	SDS +
E910501 ●	P	Ø12mm L200		Boor-Mèche
E910520 ●	Z			
0BS09 ●	R	M16 F L250 M16 M		Verlengstuk-Rallonge

De referenties met ● zijn in voorraad

Les références avec ● sont en stock.

07-2023  
069

**anymex**

# Premium

**Droog en nat boren**  
**Perçage à sec et à eau**

Seg.Laser gelast / Seg.Soudure Laser



## FCPA

KOPPELING / ACCOUPLEMENT / EINSATZ / ATTACCO : **1"1/4 W.F.**

LENGTE / LONGUEUR / LÄNGE / LUNGHEZZA : **300 mm**

Toepassing : Beton(gewapend),Baksteen,steen.

Applications : Béton(armé),Briques,Pierres.

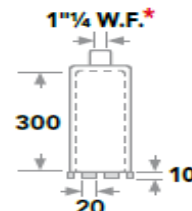

Code-Kode

Code

Ø

Z



Code-Kode	Code	Ø	Z		
E93B032		32	4	3,2	8024788014655
E93B042		42	4	3,2	8024788014662
E93B052	•	52	5	3,5	8024788014679
E93B062	•	62	5	3,5	8024788014686
E93B072	•	72	6	3,5	8024788014693
E93B082	•	82	6	3,5	8024788014709
E93B102	•	102	7	3,5	8024788014716
E93B112	•	112	7	3,5	8024788014723
E93B122		122	8	3,5	8024788014730
E93B127	•	127	8	3,5	8024788014747
E93B132	•	132	8	3,5	8024788014754
E93B142		142	8	3,5	8024788014761
E93B152	•	152	8	3,5	8024788014778
E93B162	•	162	9	3,5	8024788014785
E93B182		182	9	3,8	8024788014792
E93B202		202	10	3,8	8024788014808



**C7-8-9-10**



\* GROEVEN VOOR AFVOER VAN MATERIALEN - RAINURE POUR L'EVACUATION DES MATERIAUX

### Centreerkruis voor FCPA - Croix de centrage pour FCPA

Code-Kode	Type	Tool	
0BC10	• C7	Centreerkruis, boor Ø8 tot-jusque Ø 62	8024788011616
0BC11	• C8	Croix de centrage,mèche Ø8 Van-de Ø 67 tot- à Ø 92	8024788011623
0BC12	• C9	Centreerkruis,boor Ø8 Van-de Ø 102 tot- à Ø 152	8024788011630
0BC13	• C10	Croix de centrage,mèche Ø8 Van-de Ø 142 tot- à Ø 202	8024788011647

De referenties met • zijn in voorraad

Les références avec • sont en stock.

07-2023  
070

**anymex**

# Premium

Nat boren  
Perçage à eau

Seg.Laser gelast / Seg.Soudure Laser



## FCAP

KOPPELING / ACCOUPLEMENT : 1"1/4 W.F.

LENGTE/ LONGUEUR : 450 mm

Toepassing : Beton(gewapend),Baksteen.

Applications : Béton(armé),Briques .

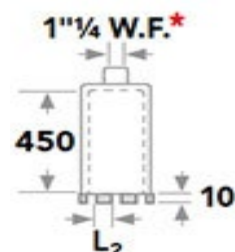

Code-Kode

Codice

Ø



Z

L<sup>2</sup>

E94G032	32	3,2	3	17
E94G037	37	3,2	4	17
E94G042	42	3,2	5	17
E94G047	47	3,2	5	17
E94G052	52	3,2	6	17
E94G057	57	3,2	5	24
E94G062	62	3,2	5	24
E94G067	67	3,2	5	24
E94G072	72	3,2	6	24
E94G082	82	3,2	7	24
E94G092	92	3,2	8	24
E94G102	102	3,4	9	24
E94G107	107	3,4	9	24
E94G112	112	3,4	9	24
E94G122	122	3,4	9	24
E94G127	127	3,4	10	24
E94G132	132	3,6	10	24
E94G142	142	3,6	11	24
E94G152	152	3,6	12	24
E94G162	162	3,6	12	24
E94G182	182	3,6	13	24
E94G201	201	4,0	14	24
E94G231	231	4,0	15	24
E94G251	251	4,0	16	24
E94G300	300	4,4	18	24
E94G350	350	4,4	19	24
E94G400	400	4,4	21	24
E94G500	500	4,4	23	24

\* GROEVEN VOOR AFVOER VAN MATERIALEN - RAINURE POUR L'EVACUATION DES MATERIAUX

\* Segementen zijn ingezet in de staalplaat - Segements inseré dans la tôle

De referenties met ● zijn in voorraad

Les références avec ● sont en stock.

07-2023  
071

**anymex**

# Verkoopsystemen Systèmes de vente





**De juiste verkoopsystemen voor elke ruimte: van toonbankdisplays tot en met complete presentatiewanden.**

**Les systèmes de vente appropriés pour chaque espace : des présentoirs de comptoir jusqu'à des murs de présentation complets.**

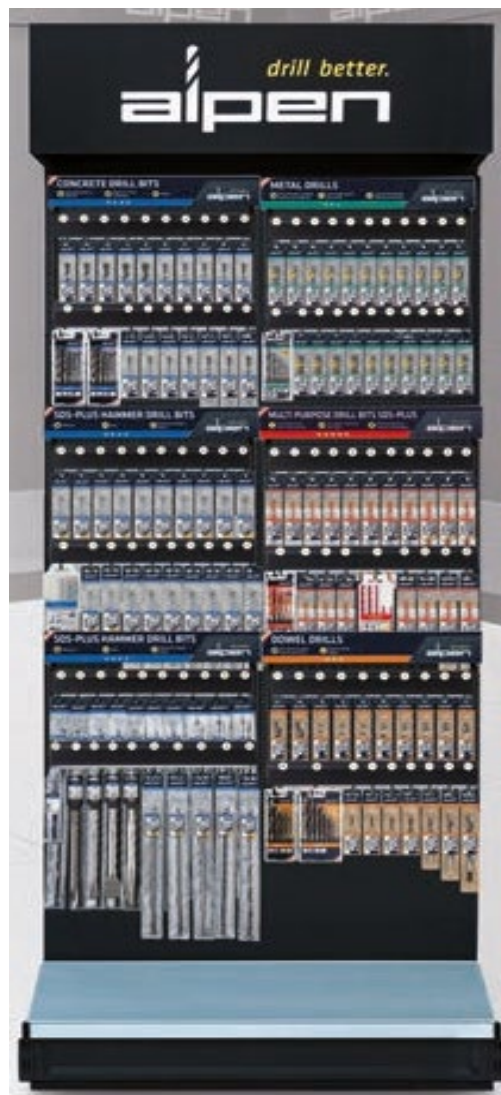

**Verschillende modules beschikbaar**

**Différents modules disponibles**



**Wij sturen u graag een aangepaste offerte op maat van uw behoeften.**

**Nous nous ferons un plaisir de vous faire parvenir une offre spécialement adaptée à vos besoins.**

**Scharfe Schneiden**

auch bei größeren Durchmessern wenig Vorschubdruck erforderlich

**Sharp cutting edges**

even with larger diameters little feed pressure is required

**Filos bien afilados**

Con diámetros más grandes, se necesita menos presión de avance

**Sehr hohe Elastizität**

und höchste Zähigkeit bei optimaler Schneidleistung

**Very high elasticity**

and greatest toughness with optimum cutting performance

**Elasticidad muy elevada**

y la mayor resistencia con una capacidad óptima de corte

**Hohe Bruchstabilität**

auch bei kleineren Durchmessern geringe Bruchgefahr durch hohe Elastizität

**High fracture resistance**

even with smaller diameters low risk of breakage due to high elasticity

**Gran resistencia a la rotura**

Con diámetros más pequeños, existe un riesgo menor de rotura debido a la gran elasticidad

**Optimale Bohrleistung**

auch bei ungünstigen Arbeitsbedingungen

**Optimum drilling performance**

even in unfavourable working conditions

**Capacidad de perforación óptima**

incluso en condiciones de trabajo desfavorables



# Cardboard Display "Sprint Master"



Ref.	Bar code EAN13	Artikel-Article	
34A098000831		Display 15 cassettes 6 st/pcs Ø 2,0-3,0-4,0-5,0-6,0-8,0 mm	1



Ref.	Bar code EAN13	Artikel-Article	Inh-Cont.	
34A008111221	9002741208524	Cassettes Ø 2,0-3,0-4,0-5,0-6,0-8,0 mm	1	10

# Sprint MASTER Metaal boor Mèches Métal



Ref.	Ø mm	l1 mm	l2 mm	Bar code EAN13	Inh-Cont.	
34A618002001	2,00	49	24	9002741208616	3	10
34A618002501	2,50	57	30	9002741208623	3	10
34A618003001	3,00	61	33	9002741208630	3	10
34A618003201	3,20	65	36	9002741208647	3	10
34A618003501	3,50	70	39	9002741208661	2	10
34A618004001	4,00	75	43	9002741208678	2	10
34A618004201	4,20	75	43	9002741208685	2	10
34A918004501	4,50	80	47	9002741208692	2	10
34A618005001	5,00	86	52	9002741208715	2	10
34A618005501	5,50	93	57	9002741208722	2	10
34A618006001	6,00	93	57	9002741208739	2	10
34A618006501	6,50	101	63	9002741208746	1	10
34A618007001	7,00	109	69	9002741208760	1	10
34A618008001	8,00	117	75	9002741208784	1	10
34A618008501	8,50	117	75	9002741208791	1	10
34A618009001	9,00	125	81	9002741208807	1	10
34A618010001	10,00	133	87	9002741208821	1	10
34A618012001	12,00	151	101	9002741208876	1	10
34A618013001	13,00	151	101	9002741208890	1	10



HSS Boor met gereduceerde staart Ø 9,5

HSS Mèche avec queue réduite Ø 9,5

Ref.	Ø mm	l1 mm	l2 mm	Bar code EAN13	Inh-Cont.	
34A640012501	12,50	151	101	9002741211852	1	10
34A640014001	14,00	160	108	9002741211753	1	8
34A640014501	14,50	169	114	9002741211883	1	8
34A640016001	16,00	178	120	9002741211746	1	8

# C PROTECTOR

Tegels-Faeince-Harde Porselein / Carrelage-Faïence-Porcelaine dure



Ref.	∅ mm	l1 mm	Bar code EAN13	Inh-Cont.	
34A303005001	5,00	105	9002741293841	1	10
34A303006001	6,00	115	9002741293858	1	10
34A303008001	8,00	120	9002741293865	1	10
34A303010001	10,00	120	9002741293872	1	10
34A303012001	12,00	120	9002741293889	1	10



**+ Profi Beton**



Ref.	∅ mm	l1 mm	Bar code EAN13	Inh-Cont.	
34A003030521	5,00	105	9002741294381	2	10
34A003030621	6,00	115	9002741294398	2	10
34A003030821	8,00	120	9002741294428	2	10
34A003031021	10,00	120	9002741294435	2	10

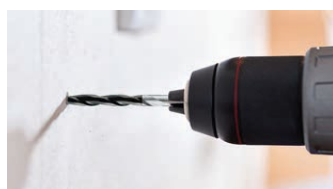

## Cardboard Display

34A098001671	Display 5st/pcs ∅6-∅8-∅10	Tot.15 st/pcs	1
--------------	---------------------------	---------------	---



# Boor voor tegels,faience,glas,rode steen Mèche pour carrelage,faience,verre,brique rouge

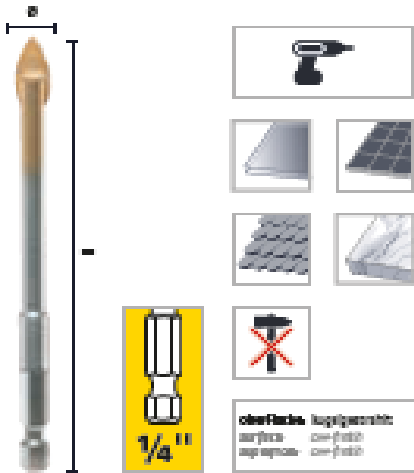

**Tungsten Carbide**

Ref.	Ø mm	l1 mm	Bar code EAN13	Inh-Cont.	
34A411020	5,00	105	3509094110208	1	10
34A411030	6,00	105	3509094110307	1	10
34A411050	8,00	110	3509094110604	1	10
34A411060	10,00	130	3509094110604	1	10

## Nieuwe referenties - Nouvelle références

Ref.	Ø mm	l1 mm	Bar code EAN13	Inh-Cont.	
34A289003001	3,00	100	9002740230106	1	10
34A289004001	4,00	100	9002740230113	1	10
34A289005001	5,00	105	9002740230120	1	10
34A289006001	6,00	105	9002740230137	1	10
34A289008001	8,00	110	9002740230144	1	10
34A289010001	10,00	110	9002740230151	1	10
34A289012001	12,00	113	9002741086825	1	10

Ref.	Ø mm	Bar code EAN13	Inh-Cont.		
34A289000031	5,0-6,0-8,0	3 st/pcs	9002741165568	1	5



# TC Ceramic

**Hoog rendement boor voor het boren van tegels, keramiek en marmer.**

**Alleen roterend.**

**Mèche à haute efficacité pour le perçage des Carrelages, céramique et marbre.**

**Rotatif seulement.**



## Tungsten Carbide

Ref.	Ø mm	l1 mm	l2 mm	Bar code EAN13	Inh-Cont.	
34A297004001	4,00	75	39	9002740230304	1	10
34A297005001	5,00	85	39	9002740230311	1	10
34A297006001	6,00	100	54	9002740230335	1	10
34A297006501	6,50	100	54	9002740342441	1	10
34A297008001	8,00	120	80	9002740230359	1	10
34A297010001	10,00	120	80	9002740230366	1	10
34A297012001	12,00	150	90	9002740230373	1	10

**Diamant tegel boor met sjabloon en water koeling systeem  
Voor harde ceramiek tegels,marmer,graniet,porselein**

**Foret diamanté avec insert et réservoir d'eau pour refroidissement  
Pour carrelage en céramique dure, marbre, granit, porcelaine**



**Geschikt voor elke accuboormachine. Niet geschikt voor het boren met percussie.  
Waterkoeling noodzakelijk**

**Convient à toutes les perceuse sans fil. Ne convient pas pour le forage à percussion.  
Refroidissement par eau nécessaire.**

Ref.	∅ mm	l1 mm	Bar code EAN13	
34A290600	6	60	9002740900955	1
34A290800	8	60	9002740900962	1
34A291000	10	60	9002740900979	1
34A291200	12	60	9002740900993	1
34A291500	15	60	9002740901006	1



**De all-rounder Steen-hout-plastiek-blauwsteen-ceramiek  
carbide punt,extra scherpe snijkanten dus ook geschikt voor metaal.**

## PROFI MULTICUT



### Der Allesstönner

*The all-rounder  
Il tuttofare*

### Hartmetallplatte

Extra scharfe Schneiden, deshalb  
bestens auch für Metall geeignet

### Carbide tip

*Extra sharp cutting edges, so very  
well suited for metal too*

### Placchetta in Metallo Duro

*taglien ti super affilati e quindi idonei  
anche alla foratura di metallo*

### Patentiertes 4-fach Stufenprofil

Schnelle Bohrmehlförderung beim  
Bohren in Mauerwerk und Beton

### Patented 4-step profile

*Fast drill dust feed when drilling in to  
masonry and concrete*

### Profilo brevettato a 4 fasi

*veloce evacuazione delle polveri dur-  
ante la foratura in muro e cemento*

### Verschiedene Längen

bis zu 400 mm verfügbar

### Various lengths

up to 400 mm available

### Diverse lunghezze

disponibile fino a 400 mm

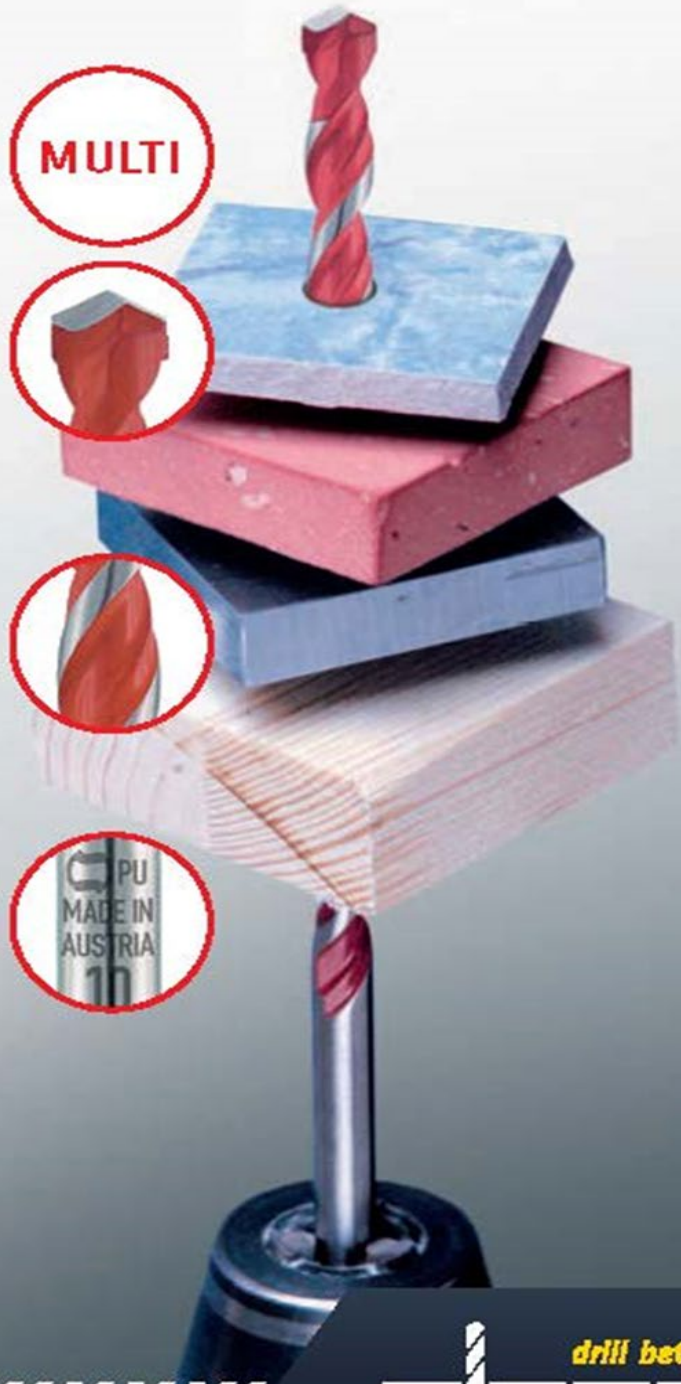

**alpen** *drill better.*

**Le all-rounder Pierre-bois-plastique(PVC)-pierre bleu-céramique  
Pointe carbide,extra tranchants,très adapté pour le métal .**

# Profi Multicut



Ref.	∅ mm	l1 mm	l2 mm	Bar code EAN13	Inh-Cont.	
34A172003001	3,00	60	30	9002741152070	1	10
34A172004001	4,00	75	39	9002740008101	1	10
34A172005001	5,00	85	39	9002740008118	1	10
34A172005501	5,50	85	39	9002740008125	1	10
34A172006001	6,00	100	54	9002740008132	1	10
34A172006501	6,50	100	54	9002740008149	1	10
34A172007001	7,00	100	54	9002740008156	1	10
34A172008001	8,00	120	80	9002740008163	1	10
34A172010001	10,00	120	80	9002740008170	1	10
34A172012001	12,00	150	90	9002741152087	1	10

## Lengte-Longueur 150/85 mm & 200/135mm

Ref.	∅ mm	l1 mm	l2 mm	Bar code EAN13	Inh-Cont.	
34A729005001	5,00	150	85	9002740000235	1	10
34A729005501	5,50	150	85	9002740006770	1	10
34A729006001	6,00	200	135	9002740000242	1	10
34A729006501	6,50	200	135	9002740006787	1	10
34A729007001	7,00	200	135	9002740006794	1	10
34A729008001	8,00	200	135	9002740000259	1	10
34A729010001	10,00	200	135	9002740000280	1	10
34A729012001	12,00	220	150	9002740000266	1	10
34A729014001	14,00	220	150	9002740000273	1	10

## Lengte-Longueur 400/300 mm

Ref.	∅ mm	l1 mm	l2 mm	Bar code EAN13	Inh-Cont.	
34A730005001	5,00	400	300	9002741210206	1	10
34A730005501	5,50	400	300	9002741210190	1	10
34A730006001	6,00	400	300	9002741045921	1	10
34A730006501	6,50	400	300	9002741045938	1	10
34A730008001	8,00	400	300	9002741045945	1	10
34A730010001	10,00	400	300	9002741045952	1	10
34A730012001	12,00	400	300	9002741045969	1	10
34A730014001	14,00	400	300	9002741045976	1	10
34A730016001	16,00	400	300	9002741045983	1	10

Ref.	∅ mm	Bar code EAN13	Inh-Cont.	
34A001007031	Caset 5,0-6,0-8,0 3 st/pcs	9002741123346	1	5
Ref.	∅ mm	Bar code EAN13	Inh-Cont.	
34A001007051	Caset 4,0-5,0-6,0-8,0-10,0 5st/pc	9002741011346	1	5



# Profi Multicut SDS+

## Special SDS+ staaf met Hamer Stop functie Tige Spécial SDS+ Avec arrêt de Percussion

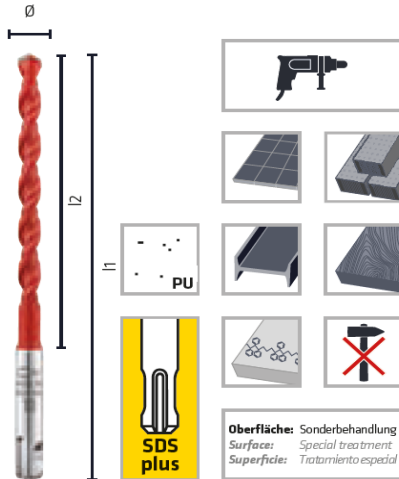

**Automatische  
Schlag-Stopp-Funktion**  
*Automatic  
hammer-stop function*  
*Función automática  
de parada de percusión*



### Lengte-Longueur 110/50mm

Ref.	Ø mm	l1 mm	l2 mm	Bar code EAN13	Inh-Cont.	
34A509005001	5,00	110	50	9002741150977	1	10
34A509006001	6,00	110	50	9002741150984	1	10
34A509008001	8,00	110	50	9002741150991	1	10

### Lengte-Longueur 160/100mm

Ref.	Ø mm	l1 mm	l2 mm	Bar code EAN13	Inh-Cont.	
34A519005001	5,00	160	100	9002741263899	1	10
34A519006001	6,00	160	100	9002741151004	1	10
34A519007001	7,00	160	100	9002741263905	1	10
34A519008001	8,00	160	100	9002741151011	1	10
34A519010001	10,00	160	100	9002741151028	1	10
34A519012001	12,00	160	100	9002741172337	1	10
34A519014001	14,00	160	100	9002741172344	1	10

### Lengte-Longueur 210/150mm

Ref.	Ø mm	l1 mm	l2 mm	Bar code EAN13	Inh-Cont.	
34A529006001	6,00	210	150	9002741172351	1	10
34A529008001	8,00	210	150	9002741151035	1	10
34A529010001	10,00	210	150	9002741151042	1	10
34A529012001	12,00	210	150	9002741151059	1	10
34A529014001	14,00	210	150	9002741172368	1	10



### Lengte-Longueur 260/200mm

Ref.	Ø mm	l1 mm	l2 mm	Bar code EAN13	Inh-Cont.	
34A539006001	6,00	260	200	9002741163366	1	10
34A539006501	6,50	260	200	9002741161218	1	10
34A539008001	8,00	260	200	9002741161225	1	10
34A539010001	10,00	260	200	9002741161232	1	10
34A539012001	12,00	260	200	9002741161249	1	10
34A539014001	14,00	260	200	9002741163359	1	10
34A539016001	16,00	260	200	9002741163342	1	10



### Lengte-Longueur 450/400mm

### Nieuw-Nouveaux lengte/longueur 450mm

Ref.	Ø mm	l1 mm	l2 mm	Bar code EAN13	Inh-Cont.	
34A579006501	6,50	450	400	9002741268740	1	5
34A579008001	8,00	450	400	9002741236671	1	5
34A579010001	10,00	450	400	9002741192427	1	5
34A579012001	12,00	450	400	9002741240364	1	5
34A579014001	14,00	450	400	9002741240371	1	5
34A579016001	16,00	450	400	9002741240357	1	5
34A579018001	18,00	450	400	9002741240340	1	5
34A579020001	20,00	450	400	9002741240333	1	5



34A579000041				9002741263813		1
--------------	--	--	--	---------------	--	---

**Set/Box 4 st/pcs Ø 8.0-10.0-12.0-16.0  
Lengte-Longueur 450mm**



Ref.	Ø mm	Bar code EAN13	Inh-Cont.	
34A001009051	5,0-6,0x110mm-6,0-8,0-10,0x160mm 5 st/pcs	9002741156368	1	5



## F4 FORTE



**Patentierter Hartmetallplatte**  
mit exzellenten Zentriereigen-  
schaften

*Patented carbide tip*  
with excellent centering properties

*Plancha de metal duro patentada*  
con excelentes propiedades de  
centrado



**Patentiertes 4-fach Stufenprofil**  
für schnelle Bohrmehlförderung

*Patented 4-step profile*  
for fast drill dust feed

*Perfil cuádruple escalonado paten-  
tado*  
para la eliminación rápida  
de los detritos.

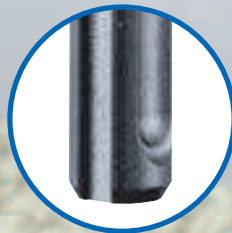

# Boren SDS+ Mèches SDS+



## Lengte-Longueur 110/50 mm

Ref.	Ø mm	l1 mm	l2 mm	Bar code EAN13	Inh-Cont.	
34A807004001	4,00	110	50	9002740234340	1	10
34A807005001	5,00	110	50	9002740234364	1	10
34A807005501	5,50	110	50	9002740234371	1	10
34A807006001	6,00	110	50	9002740234388	1	10
34A807006501	6,50	110	50	9002740234401	1	10
34A807007001	7,00	110	50	9002740234418	1	10
34A807008001	8,00	110	50	9002740234432	1	10
34A807010001	10,00	110	50	9002740234449	1	10

## Lengte-Longueur 160/100 mm

Ref.	Ø mm	l1 mm	l2 mm	Bar code EAN13	Inh-Cont.	
34A817004001	4,00	160	100	9002740661498	1	10
34A817005001	5,00	160	100	9002740234494	1	10
34A817005501	5,50	160	100	9002740234500	1	10
34A817006001	6,00	160	100	9002740234517	1	10
34A817006501	6,50	160	100	9002740234531	1	10
34A817007001	7,00	160	100	9002740234548	1	10
34A817008001	8,00	160	100	9002740234579	1	10
34A817009001	9,00	160	100	9002740385769	1	10
34A817009501	9,50	160	100	9002740579373	1	10
34A817010001	10,00	160	100	9002740234593	1	10
34A817011001	11,00	160	100	9002740234609	1	10
34A817012001	12,00	160	100	9002740234623	1	10
34A817013001	13,00	160	100	9002740234647	1	10
34A817014001	14,00	160	100	9002740234654	1	10
34A817015001	15,00	160	100	9002740234678	1	10
34A817016001	16,00	160	100	9002740277637	1	10



## Lengte-Longueur 210/150 mm

Ref.	Ø mm	l1 mm	l2 mm	Bar code EAN13	Inh-Cont.	
34A827005001	5,00	210	150	9002740601364	1	8
34A827005501	5,50	210	150	9002740632696	1	8
34A827006001	6,00	210	150	9002740350385	1	8
34A827006501	6,50	210	150	9002740567431	1	8
34A827007001	7,00	210	150	9002740418238	1	8
34A827008001	8,00	210	150	9002740234746	1	8
34A827009001	9,00	210	150	9002740234753	1	8
34A827010001	10,00	210	150	9002740234760	1	8
34A827012001	12,00	210	150	9002740234777	1	8
34A827014001	14,00	210	150	9002740234784	1	8
34A827015001	15,00	210	150	9002740404187	1	8
34A827016001	16,00	210	150	9002740234791	1	8
34A827017001	17,00	210	150	9002741109791	1	8
34A827018001	18,00	210	150	9002740235408	1	8
34A827019001	19,00	210	150	9002740235415	1	8
34A827020001	20,00	210	150	9002740235422	1	8

## Lengte-Longueur 260/200 mm

Ref.	Ø mm	l1 mm	l2 mm	Bar code EAN13	Inh-Cont.	
34A837005001	5,00	260	200	9002741133802	1	8
34A837005501	5,50	260	200	9002740980353	1	8
34A837006001	6,00	260	200	9002740351214	1	8
34A837006501	6,50	260	200	9002740593942	1	8
34A837007001	7,00	260	200	9002740978138	1	8
34A837008001	8,00	260	200	9002740234814	1	8
34A837010001	10,00	260	200	9002740234838	1	8
34A837011001	11,00	260	200	9002740234845	1	8
34A837012001	12,00	260	200	9002740234852	1	8
34A837013001	13,00	260	200	9002740234876	1	8
34A837014001	14,00	260	200	9002740234883	1	8
34A837015001	15,00	260	200	9002740234890	1	8
34A837016001	16,00	260	200	9002740234913	1	8
34A837018001	18,00	260	200	9002740418245	1	8
34A837020001	20,00	260	200	9002740418252	1	8
34A837022001	22,00	260	200	9002740235446	1	8
34A837024001	24,00	260	200	9002740235460	1	8
34A837025001	25,00	260	200	9002740235477	1	8
34A837026001	26,00	260	200	9002740235484	1	8



## Lengte-Longueur 310/250 mm

Ref.	Ø mm	l1 mm	l2 mm	Bar code EAN13	Inh-Cont.	
34A847005001	5,00	310	250	9002741051519	1	8
34A847005501	5,50	310	250	9002740980360	1	8
34A847006001	6,00	310	250	9002740588146	1	8
34A847006501	6,50	310	250	9002740980377	1	8
34A847007001	7,00	310	250	9002740685524	1	8
34A847008001	8,00	310	250	9002740587590	1	8
34A847010001	10,00	310	250	9002740234968	1	8
34A847012001	12,00	310	250	9002740346197	1	8
34A847013001	13,00	310	250	9002740352624	1	8
34A847014001	14,00	310	250	9002740235019	1	8
34A847016001	16,00	310	250	9002740235040	1	8
34A847018001	18,00	310	250	9002740319023	1	8
34A847019001	19,00	310	250	9002740593478	1	8
34A847020001	20,00	310	250	9002740235545	1	8
34A847022001	22,00	310	250	9002740418269	1	8
34A847024001	24,00	310	250	9002740418276	1	8
34A847025001	25,00	310	250	9002740632825	1	8

## Lengte-Longueur 450/400 mm

Ref.	Ø mm	l1 mm	l2 mm	Bar code EAN13	Inh-Cont.	
34A877005001	5,00	450	400	9002741051526	1	5
34A877005501	5,50	450	400	9002740980384	1	5
34A877006001	6,00	450	400	9002740682189	1	5
34A877006501	6,50	450	400	9002740980391	1	5
34A877008001	8,00	450	400	9002740402718	1	5
34A877010001	10,00	450	400	9002740235194	1	5
34A877012001	12,00	450	400	9002740235200	1	5
34A877013001	13,00	450	400	9002740544364	1	5
34A877014001	14,00	450	400	9002740235224	1	5
34A877015001	15,00	450	400	9002740235231	1	5
34A877016001	16,00	450	400	9002740235255	1	5
34A877018001	18,00	450	400	9002740235583	1	5
34A877020001	20,00	450	400	9002740235606	1	5
34A877022001	22,00	450	400	9002740235613	1	5
34A877024001	24,00	450	400	9002740384588	1	5
34A877025001	25,00	450	400	9002740235644	1	5
34A877026001	26,00	450	400	9002740235651	1	5





# Boren SDS+ Mèches SDS+



## Langte-Longueur 1000/950 mm

Ref.	Ø mm	l1 mm	l2 mm	Bar code EAN13	Inh-Cont.	
34A914010001	10,00	1000	950	9002740631217	1	1
34A914012001	12,00	1000	950	9002740626688	1	1
34A914014001	14,00	1000	950	9002740680857	1	1
34A914016001	16,00	1000	950	9002740626695	1	1
34A914018001	18,00	1000	950	9002740680864	1	1
34A914020001	20,00	1000	950	9002740626701	1	1
34A914025001	25,00	1000	950	9002740983330	1	1



## Plastiek cassette -Cassette plastic 5 st/pcs

Ref.	Ø mm	Bar code EAN13	Inh-Cont.	
34A807056801	5,0-6,0 x110mm-6,0-8,0-10,0x160mm	9002740335832	1	5



Box Cassette 10st/pcs →



## Metaal koffer -Coffre métallique 16 st/pcs

Ref.	L mm	
34A005000161	Metaal koffer -Coffre métallique Barcode 9002740971917	1
Ø 5,0 - 6,0	110 1	Beitels Burins
Ø 6,0 - 8,0 - 10,0 - 12,0	160 1	Punt-Pointe 250
Ø 6,0 - 8,0 - 10,0	210 1	Plat-Plat 20 / 250
Ø 8,0 - 10,0 - 12,0 - 14,0	260 1	Breed-Large 40 / 250



 **FORCE X**



**4 Vollhartmetallschneiden**

Kein Einhängen bei Armierungstreffern

**4 tungsten carbide cutting edges**

No hooking when hitting reinforcement

**4 filos de metal duro y macizo.**

No se engancha al impactar contra la armadura.



**Problemloses Durchbohren von Eisenarmierungen**

*Problem-free drilling through iron reinforcements*

*Perforación sin problemas de armaduras de hierro*



**Dübellängenindikator**

für exakte Bohrtiefe

**Dowel length indicator**

for exact drilling depth

**Indicador de longitud del anclaje**

Para una profundidad de perforación exacta.

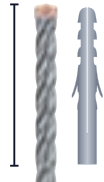

**Progressives Spiralendesign**

für schnellere Resultate

**Progressive spiral design**

for fast results

**Ranura diseñada de forma progresiva**

Para resultados más rápidos.

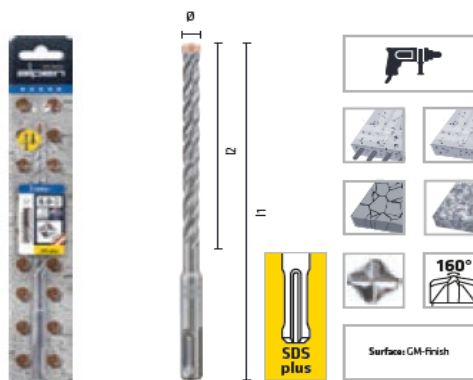
**Boren SDS+****FORCE X****Mèches SDS+****FORCE X****Lengte-Longueur 110/50 mm**

Ref.	Ø mm	l1 mm	l2 mm	Bar code EAN13	Inh-Cont.	
34A805005001	5,00	110	50	9002741265220	1	10
34A805005501	5,50	110	50	9002741265237	1	10
34A805006001	6,00	110	50	9002741265244	1	10
34A805007001	7,00	110	50	9002741265251	1	10
34A805008001	8,00	110	50	9002741265268	1	10
34A805010001	10,00	110	50	9002741265275	1	10

**Lengte-Longueur 160/100 mm**

Ref.	Ø mm	l1 mm	l2 mm	Bar code EAN13	Inh-Cont.	
34A815005001	5,00	160	100	9002741265282	1	10
34A815005501	5,50	160	100	9002741265299	1	10
34A815006001	6,00	160	100	9002741265305	1	10
34A815006501	6,50	160	100	9002741265312	1	10
34A815007001	7,00	160	100	9002741265329	1	10
34A815008001	8,00	160	100	9002741265336	1	10
34A815009001	9,00	160	100	9002741265343	1	10
34A815010001	10,00	160	100	9002741265350	1	10
34A815012001	12,00	160	100	9002741265367	1	10
34A815014001	14,00	160	100	9002741265374	1	10
34A815015001	15,00	160	100	9002741265381	1	10
34A815016001	16,00	160	100	9002741265398	1	10

**Lengte-Longueur 210/150 mm**

Ref.	Ø mm	l1 mm	l2 mm	Bar code EAN13	Inh-Cont.	
34A825005001	5,00	210	150	9002741265404	1	8
34A825006001	6,00	210	150	9002741265411	1	8
34A825006501	6,50	210	150	9002741265428	1	8
34A825008001	8,00	210	150	9002741265435	1	8
34A825009001	9,00	210	150	9002741311606	1	8
34A825010001	10,00	210	150	9002741265442	1	8
34A825012001	12,00	210	150	9002741265459	1	8
34A825014001	14,00	210	150	9002741265466	1	8
34A825016001	16,00	210	150	9002741265473	1	8



## Lengte-Longueur 260/200 mm

Ref.	∅ mm	l1 mm	l2 mm	Bar code EAN13	Inh-Cont.	
34A835006001	6,00	260	200	9002741265480	1	8
34A835006501	6,50	260	200	9002741265497	1	8
34A835008001	8,00	260	200	9002741265503	1	8
34A835009001	9,00	260	200	9002741265510	1	8
34A835010001	10,00	260	200	9002741265527	1	8
34A835012001	12,00	260	200	9002741265534	1	8
34A835014001	14,00	260	200	9002741265541	1	8
34A835015001	15,00	260	200	9002741265558	1	8
34A835016001	16,00	260	200	9002741265565	1	8
34A835018001	18,00	260	200	9002741277766	1	8
34A835020001	20,00	260	200	9002741277773	1	8
34A835022001	22,00	260	200	9002741277780	1	8
34A835024001	24,00	260	200	9002741277797	1	8
34A835025001	25,00	260	200	9002741277803	1	8

## Lengte-Longueur 310/250 mm

Ref.	∅ mm	l1 mm	l2 mm	Bar code EAN13	Inh-Cont.	
34A845006001	6,00	310	250	9002741265572	1	8
34A845006501	6,50	310	250	9002741265589	1	8
34A845008001	8,00	310	250	9002741265596	1	8
34A845010001	10,00	310	250	9002741265602	1	8
34A845012001	12,00	310	250	9002741265619	1	8
34A845014001	14,00	310	250	9002741265626	1	8
34A845016001	16,00	310	250	9002741265633	1	8

## Lengte-Longueur 450/400 mm

Ref.	∅ mm	l1 mm	l2 mm	Bar code EAN13	Inh-Cont.	
34A875008001	8,00	450	400	9002741265640	1	5
34A875010001	10,00	450	400	9002741265657	1	5
34A875012001	12,00	450	400	9002741265664	1	5
34A875014001	14,00	450	400	9002741265671	1	5
34A875016001	16,00	450	400	9002741265688	1	5
34A875018001	18,00	450	400	9002741278169	1	5
34A875020001	20,00	450	400	9002741277728	1	5
34A875022001	22,00	450	400	9002741277735	1	5
34A875024001	24,00	450	400	9002741277742	1	5
34A875025001	25,00	450	400	9002741277759	1	5
34A875028001	28,00	450	400	9002741281398	1	5
34A875030001	30,00	450	400	9002741281404	1	5
34A875032001	32,00	450	400	9002741281411	1	5



# Boren SDS+



# Mèches SDS+

## Lengte-Longueur 1000/950 mm

Ref.	∅ mm	l1 mm	l2 mm	Bar code EAN13	Inh-Cont.	
34A915010001	10,00	1000	950	9002741277278	1	1
34A915012001	12,00	1000	950	9002741277285	1	1
34A915014001	14,00	1000	950	9002741277292	1	1
34A915016001	16,00	1000	950	9002741277315	1	1



## Plastiek cassette -Cassette plastic 5 st/pcs



Ref.	∅ mm	Bar code EAN13	Inh-Cont.	
34A805000051	5,0-6,0 x110mm-6,0-8,0-10,0x160mm	9002741276837	1	5



Box Cassette 10st/pcs →



## Metaal koffer -Coffre métallique 16 st/pcs



Ref.	L mm	
34A005002161	Metaal koffer -Coffre métallique Barcode 9002741276912	1
∅ 5,0 - 6,0	110     1	Beitels Burins
∅ 6,0 - 8,0 - 10,0 - 12,0	160     1	Punt-Pointe     250
∅ 6,0 - 8,0 - 10,0	210     1	Plat-Plat     20 / 250
∅ 8,0 - 10,0 - 12,0 - 14,0	260     1	Breed-Large     40 / 250



## Adapter SDS Max >> SDS+ / Conversion SDS Max >> SDS+



Conversie Adapter van SDS Max naar SDS+  
Adaptateur de conversion SDS Max vers SDS+

Ref.	l1 mm		Bar code EAN13		
34A996000211	223		9002740624851		1

## Beitels SDS+ Demolisher Plus Burins SDS+ Demolisher Plus



Ref.	l1 mm		Bar code EAN13		
34A987002511	250		9002741260805		1

NEW



Ref.	l1 mm	B-L	Bar code EAN13		
34A987002521	250	20	9002741260812		1

NEW



Ref.	l1 mm	B-L	Bar code EAN13		
34A987002531	250	40	9002741260829		1

NEW

# Beitels SDS+ / Burins SDS+

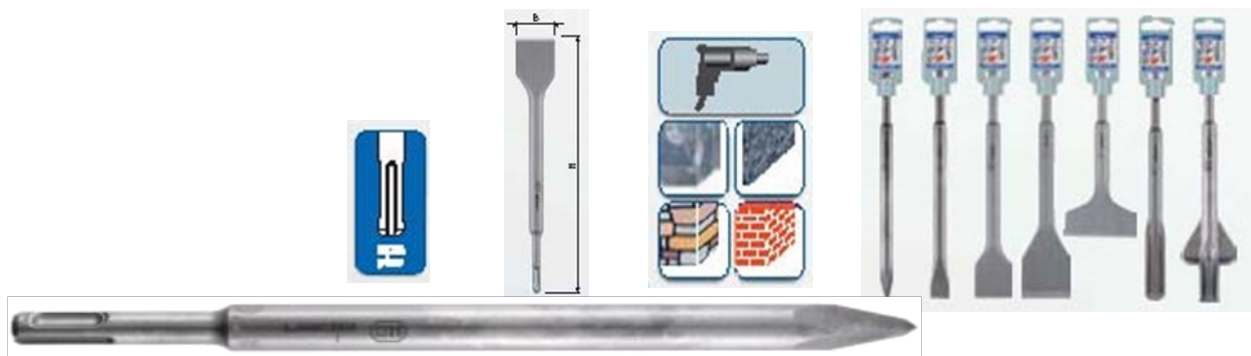

Ref.	l1 mm		Bar code EAN13		
34A980002501	250		9002740612537		1



Ref.	l1 mm	B/L mm	Bar code EAN13		
34A981002501	250	20	9002740612544		1



Ref.	l1 mm	B/L mm	Bar code EAN13		
34A982004251	250	40	9002740612551		1



Ref.	l1 mm	B/L mm	Bar code EAN13		
34A983005051	250	50	9002740008996		1



Ref.	l1 mm	B/L mm	Bar code EAN13		
34A985001651	165	75	9002741123476		1



Ref.	l1 mm	B/L mm	Bar code EAN13		
34A983002251	250	22	9002740612568		1



Ref.	l1 mm	B/L mm	Bar code EAN13		
34A984002251	250	22	9002740897064		1

# Kroon SDS+ Carbide Couronne SDS+ Carbide



## Complete kroon-Couronne complète SDS +

Ref.	Ø mm	l1 mm		Bar code EAN13		
34A897025001	25,00	85	65	9002741275366		1
34A897030001	30,00	85	65	9002741275373		1
34A897035001	35,00	85	65	9002741275380		1
34A897040001	40,00	85	65	9002740401377		1
34A897050001	50,00	85	65	9002741275397		1
34A897066001	66,00	85	65	9002740991168		1
34A897068001	68,00	85	65	9002740991175		1
34A897080001	80,00	85	65	9002740342182		1



Ref.		l1 mm				
34A898000951		85	M16	9002740581390		1
34A898001101	SDS +	110	M16	9002740581406		1
34A898002001	SDS +	220	M16	9002740581413		1



Ref.	Ø mm	l1 mm	l2 mm			
34A899008001	8,00	110	70	9002740581420		1



## DUST EXTRACTOR SHARP



### **Der neue 2 in 1 Bohrer:**

Bohren und Staubabsaugen in einem Schritt

### **The new 2-in-1 drill bit:**

Drilling and dust extraction in a single step

### **La nueva broca 2 en 1:**

Perforar y aspirar el polvo en un paso

### **Saubere, staubfreie Bohrlöcher**

für das Setzen chemischer Dübel

### **Clean, dust-free drill holes**

for inserting chemical anchors

### **Orificios limpios sin polvo**

para fijar anclajes químicos

### **Perfekt**

für Arbeiten in kritischen Bereichen,  
die staubfrei gehalten werden müssen

### **Perfect**

for working in critical areas  
that must be kept free of dust

### **Perfecto**

para trabajar en áreas sensibles,  
que no deben ser contaminados con polvo

### **Erspart lästige Reinigung der Umgebung**

Saves annoying cleaning of the surroundings

Evita la limpieza fastidiosa del ambiente

### **Schützt den Anwender**

vor gesundheitlichen Belastungen

### **Protects the user**

from damage to health

### **Protege al usuario**

de problemas de salud

### **Entfernt den Bohrstaub bereits bei der Entstehung am Bohrkopf!**

Removes the drilling dust  
where it originates at the drill tip!

Elimina el polvo ya en el momento de su  
formación en la punta de la broca



# SDS+ Afzuigboor Foret d'Aspiration SDS+

De SDS + hamerboor met afzuiging met weinig slijtage en onderhoud en zeer lange levensduur. Krachtige boor voor het boren in beton, natuursteen en Metselwerk.

Foret marteau SDS + pour le forage par aspiration, avec peu d'usure et très peu d'entretien et une longue durée de vie. Foret haute performance pour perçage au marteau dans le béton, la pierre naturelle et la maçonnerie.

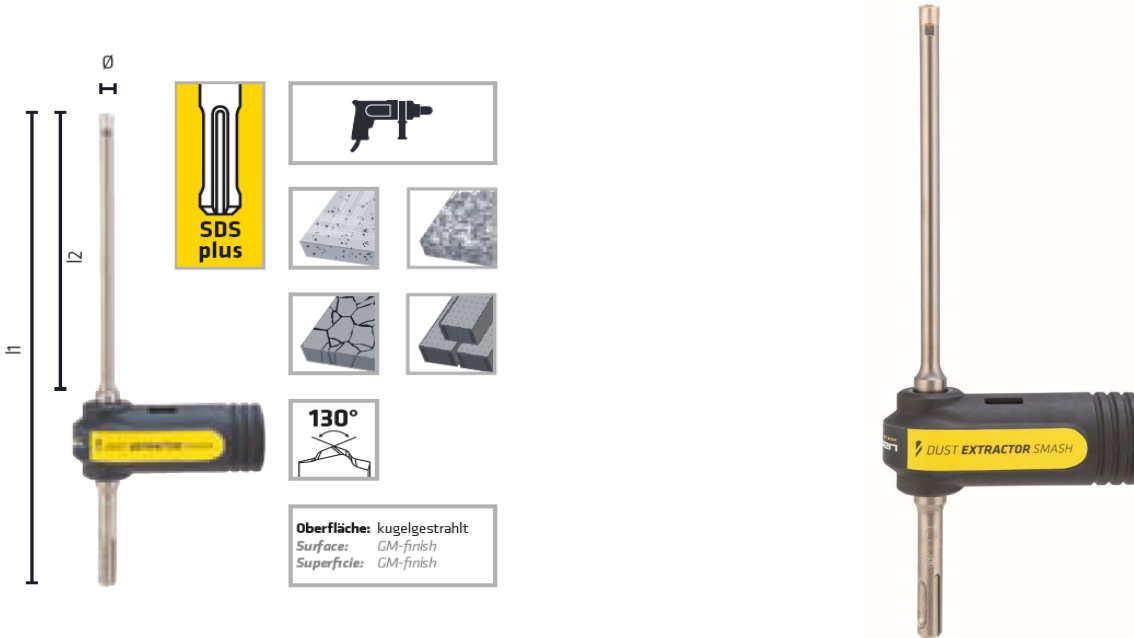

Oberfläche: kugelgestraht  
Surface: GM-finish  
Superficie: GM-finish

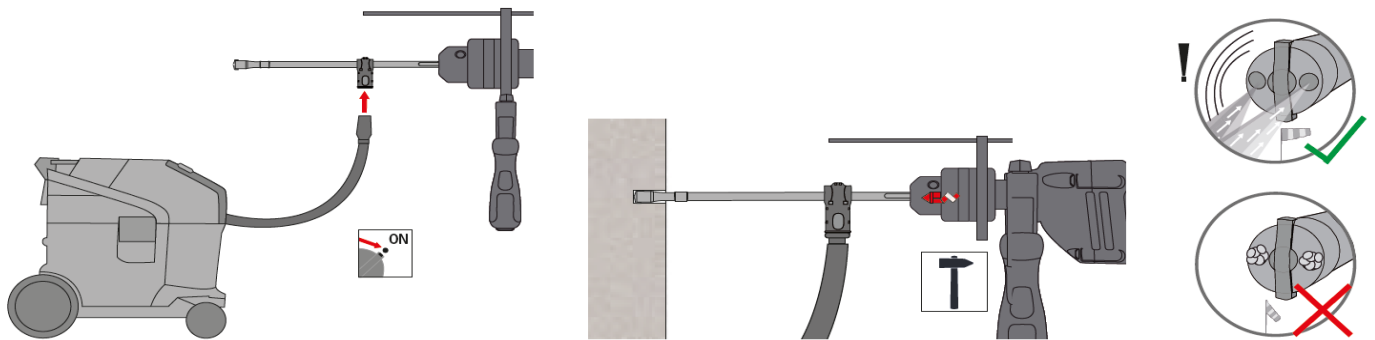

Ref.	Ø mm	l1 mm		Bar code EAN13		
34A580006001	6,00	220	100	9002741278435		1
34A580008001	8,00	270	150	9002741278312		1
34A580010001	10,00	270	150	9002741278305		1
34A580012001	12,00	320	200	9002741278299		1
34A580014001	14,00	370	250	9002741278282		1
34A580016001	16,00	370	250	9002741278275		1



 **PROFI DACH**



**Hart**

Auch die härtesten Dachziegel können nicht widerstehen

**Hard**

Even the hardest roof tiles cannot resist

**Resistente**

Ni siquiera las tejas más duras se pueden resistir

**Exakt**

durch präzisionsgeschliffene Spiralnuten

**Precise**

due to precision-ground spiral flutes

**Exacta**

Gracias a las ranuras en espiral afiladas con precisión

**Passt. Sitzt. Hält.**

Durch genormtes Schaftprofil passend für jede Akkumaschine

**Fits. Sits. Holds.**

With standardised shank profile fitting every cordless drill

**Apta. Encaja. Resistente.**

Gracias al perfil de eje normativo es apta para todas las máquinas con batería



**Profi DACH**

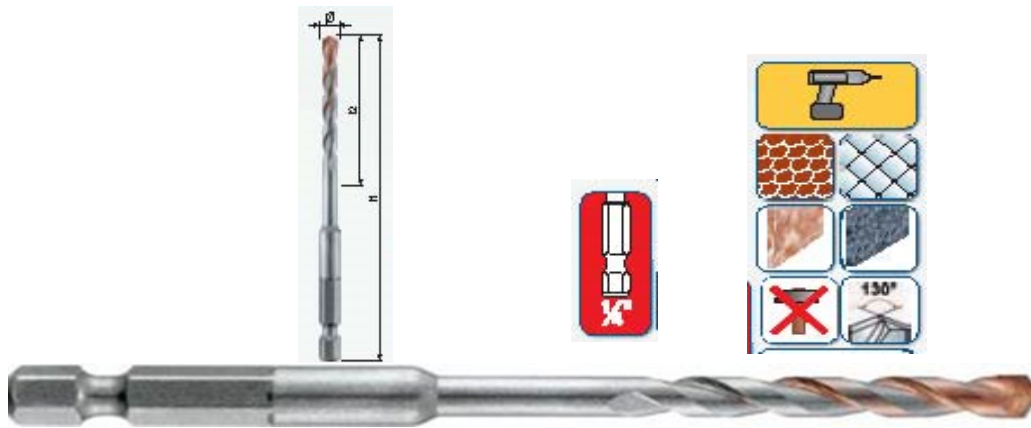

**Speciaal boor voor pannen,eternit,ceramic,marber,graniet,lesteen.**  
**Mèche spécial pour tuiles,eternit,céramic,marbre,granit,ardoise .**

Ref.	Ø mm	l1 mm	l2 mm	Bar code EAN13	Inh-Cont.	
34A252003501	3,50	100	39	9002741104581	1	10
34A252004001	4,00	100	39	9002741104567	1	10
34A252005001	5,00	100	39	9002741104628	1	10
34A252006001	6,00	100	54	9002741104543	1	10

Ref.	Ø mm	l1 mm	l2 mm	Bar code EAN13	Inh-Cont.	
34A253003501	3,50	100	39	9002741121724		10
34A253004001	4,00	100	39	9002741121731		10
34A253005001	5,00	100	39	9002741121748		10
34A253006001	6,00	100	54	9002741173235		10



**Houder 1/4 / Tête 1/4**

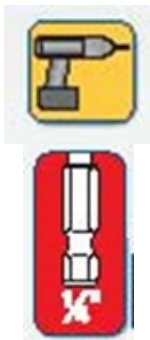

Ref.	l1 mm	Bar code EAN13	Inh-Cont.	
34A705030711	79	9002741124862	1	1

# Hout boor Type Lewis

## Mèche bois Type Lewis

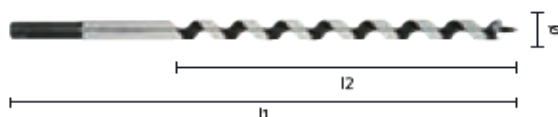
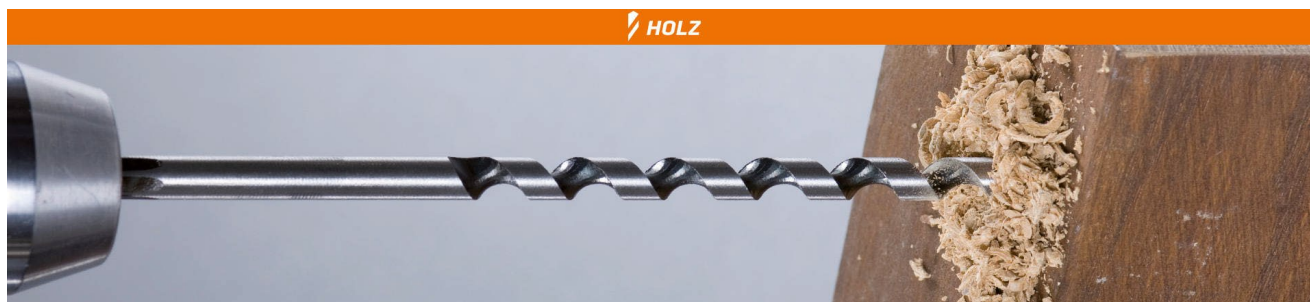

Ref.	Ø mm	l1 mm	l2 mm	Bar code EAN13	Inh-Cont.	
34A216006001	6,00	235	160	9002740584551	1	1
34A216008001	8,00	235	160	9002740219507	1	1
34A216010001	10,00	235	160	9002740219514	1	1
34A216012001	12,00	235	160	9002740219521	1	1
34A216014001	14,00	235	160	9002740219538	1	1
34A216015001	15,00	235	160	9002740691518	1	1
34A216016001	16,00	235	160	9002740219545	1	1
34A216018001	18,00	235	160	9002740219552	1	1
34A216020001	20,00	235	160	9002740219569	1	1
34A216022001	22,00	235	160	9002740672913	1	1
34A216024001	24,00	235	160	9002740672920	1	1
34A216025001	25,00	235	160	9002740672937	1	1
34A216026001	26,00	235	160	9002740672944	1	1
34A216028001	28,00	235	160	9002740672951	1	1
34A216030001	30,00	235	160	9002740672968	1	1
34A216032001	32,00	235	160	9002740672975	1	1

Ref.	Ø mm	l1 mm	l2 mm	Bar code EAN13	Inh-Cont.	
34A226008001	8,00	460	380	9002740583684	1	1
34A226010001	10,00	460	380	9002740219613	1	1
34A226012001	12,00	460	380	9002740219620	1	1
34A226014001	14,00	460	380	9002740219644	1	1
34A226016001	16,00	460	380	9002740219651	1	1
34A226018001	18,00	460	380	9002740219668	1	1
34A226020001	20,00	460	380	9002740219675	1	1
34A226022001	22,00	460	380	9002740581437	1	1
34A226024001	24,00	460	380	9002740581444	1	1
34A226025001	25,00	460	380	9002741112715	1	1
34A226026001	26,00	460	380	9002740672982	1	1
34A226028001	28,00	460	380	9002740672999	1	1
34A226030001	30,00	460	380	9002740673002	1	1
34A226032001	32,00	460	380	9002740673019	1	1



## Plat hout boor / Mèche bois platte

Ref.	Ø mm	l1 mm		Bar code EAN13	Inh-Cont.	
34A237006001	6,00	152		9002740907596	1	10
34A237008001	8,00	152		9002740907602	1	10
34A237010001	10,00	152		9002740907619	1	10
34A237012001	12,00	152		9002740907626	1	10
34A237013001	13,00	152		9002740981084	1	10
34A237014001	14,00	152		9002740907633	1	10
34A237016001	16,00	152		9002740907640	1	10
34A237017000	17,00	152		9002740981091	1	10
34A237018001	18,00	152		9002740907657	1	10
34A237019001	19,00	152		9002740981107	1	10
34A237020001	20,00	152		9002740907664	1	10
34A237022001	22,00	152		9002740907671	1	10
34A237024001	24,00	152		9002740907688	1	10
34A237025000	25,00	152		9002740981114	1	10
34A237026001	26,00	152		9002741093106	1	10
34A237028001	28,00	152		9002740981121	1	10
34A237030001	30,00	152		9002740907695	1	10
34A237032001	32,00	152		9002740907701	1	10
34A237035001	35,00	152		9002740907718	1	10
34A237038001	38,00	152		9002740907725	1	10
34A237040001	40,00	152		9002740981138	1	10



## Verlengstuk voor plat hout boor L.300mm

## Ralonge pour mèche bois platte L.300mm



Ref.				Bar code EAN13	Inh-Cont.	
34A237099991				9002741023721	1	10

Ref.	Cassette 5 stuks-pièces			Bar code EAN13	Inh-Cont.	
34A237000151	Ø 16,18,20,22,24 mm			9002741202997	1	5



## HSS Cobalt Hout-Bois Resistant 650° C

Ref.	∅ mm	l1 mm	l2 mm	Bar code EAN13	Inh-Cont.	
34A633003001	3,00	61	33	9002741181001	1	10
34A633004001	4,00	75	43	9002741181018	1	10
34A633005001	5,00	86	52	9002741181025	1	10
34A633006001	6,00	93	57	9002741181032	1	10
34A633007001	7,00	109	69	9002741181049	1	10
34A633008001	8,00	117	75	9002741181056	1	10
34A633009001	9,00	125	81	9002741181063	1	10
34A633010001	10,00	133	87	9002741181070	1	10
34A633011001	11,00	142	94	9002741181087	1	10
34A633012001	12,00	151	101	9002741181094	1	10
34A633014001	14,00	160	108	9002741181100	1	10
34A633016001	16,00	178	120	9002741181117	1	10
34A633018001	18,00	178	120	9002741181124	1	10
34A633020001	20,00	178	120	9002741181131	1	10

Ref.	Cassette 5 stuks-pièces	Bar code EAN13	Inh-Cont.	
34A633000051	∅4,5,6,8,10 mm	9002741197712	1	5

## HSS Hout-Bois 250°C

Ref.	∅ mm	l1 mm	l2 mm	Bar code EAN13		
34A616003001	3,00	61	33	9002740220299	1	10
34A616004001	4,00	75	43	9002740220305	1	10
34A616005001	5,00	86	52	9002740220312	1	10
34A616006001	6,00	93	57	9002740220329	1	10
34A616007001	7,00	109	69	9002740220336	1	10
34A616008001	8,00	117	75	9002740220343	1	10
34A616009001	9,00	125	81	9002740221999	1	10
34A616010001	10,00	133	87	9002740222002	1	10
34A616011001	11,00	142	94	9002740222019	1	10
34A616012001	12,00	151	101	9002740222026	1	10
34A616013001	13,00	151	101	9002740222033	1	10
34A616014001	14,00	160	108	9002740222040	1	8
34A616015001	15,00	169	114	9002740222057	1	8
34A616016001	16,00	178	120	9002740222064	1	8
34A616018001	18,00	178	120	9002740222088	1	8
34A616020001	20,00	178	120	9002740222095	1	8

Ref.	Cassette 8 stuks-pièces	Bar code EAN13	Inh-Cont.	
34A006000921	∅ 3→10 mm x 1 mm	9002740218197	1	1



 **LONG LIFE**



**Optimale Fixierung**  
der Hartmetallplatte im Grundkörper

*Optimum attachement*  
of the carbide tip in the core

*Fijación óptima*  
de la placa de metal duro en el cuerpo  
base

**Profil gefräst**  
wie bei SDS-Bohrern

*Profile milled*  
as with SDS bits

*Perfil fresado*  
como para las brocas SDS

**Stabiler Grundkörper**  
aus Werkzeugstahl

*Robust core*  
made of tool steels

*Cuerpo base robusto*  
de acero para herramientas





# Long Life

# TUNGSTEN CARBIDE

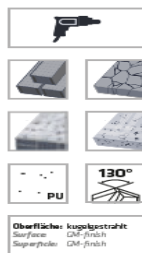

Ref.	Ø mm	l1 mm	l2 mm	Bar code EAN13	Inh-Cont.	
34A117003001	3,00	60	30	9002740224709	1	10
34A117004001	4,00	75	39	9002740224723	1	10
34A117005001	5,00	85	39	9002740224747	1	10
34A117005501	5,50	85	39	9002740224754	1	10
34A117006001	6,00	100	54	9002740224761	1	10
34A117006501	6,50	100	54	9002740224778	1	10
34A117007001	7,00	100	54	9002740224785	1	10
34A117008001	8,00	120	80	9002740224792	1	10
34A117009001	9,00	120	80	9002740224815	1	10
34A117010001	10,00	120	80	9002740224822	1	10
34A117011001	11,00	150	90	9002740224839	1	10
34A117012001	12,00	150	90	9002740224846	1	10
34A117013001	13,00	150	90	9002740224853	1	10
34A117014001	14,00	150	90	9002740224860	1	10
34A117015001	15,00	150	90	9002740224877	1	10
34A117016001	16,00	150	90	9002740224884	1	10
34A117018001	18,00	160	100	9002740224907	1	10
34A117020001	20,00	160	100	9002740224914	1	10

### Lengte-Longueur 150/90 mm

Ref.	Ø mm	l1 mm	l2 mm	Bar code EAN13	Inh-Cont.	
34A718005001	5,00	150	90	9002740342106	1	10
34A718005501	5,50	150	90	9002740342113	1	10
34A718006001	6,00	150	90	9002740342120	1	10
34A718006501	6,50	150	90	9002740342137	1	10
34A718007001	7,00	150	90	9002740342144	1	10
34A718008001	8,00	150	90	9002740342151	1	10
34A718010001	10,00	150	90	9002740342168	1	10

### Lengte-Longueur 200/140 mm

Ref.	Ø mm	l1 mm	l2 mm	Bar code EAN13	Inh-Cont.	
34A367006001	6,00	200	140	9002740230953	1	8
34A367008001	8,00	200	140	9002740230960	1	8
34A367010001	10,00	200	140	9002740230977	1	8
34A367012001	12,00	200	140	9002740230984	1	8
34A367014001	14,00	200	140	9002740230991	1	8
34A367016001	16,00	200	140	9002740898634	1	8



### Lengte-Longueur 300/220 mm

Ref.	∅ mm	l1 mm	l2 mm	Bar code EAN13	Inh-Cont.	
34A327006001	6,00	300	220	9002740674900	1	5
34A327008001	8,00	300	220	9002740674917	1	5
34A327010001	10,00	300	220	9002740674924	1	5
34A327012001	12,00	300	220	9002740674931	1	5
34A327014001	14,00	300	220	9002740674948	1	5
34A327016001	16,00	300	220	9002740674955	1	5
34A327018001	18,00	300	220	9002740674962	1	5
34A327020001	20,00	300	220	9002740674979	1	5

### Lengte-Longueur 400/300 mm

Ref.	∅ mm	l1 mm	l2 mm	Bar code EAN13	Inh-Cont.	
34A517006001	6,00	400	300	9002740231400	1	5
34A517006501	6,50	400	300	9002740382171	1	5
34A517008001	8,00	400	300	9002740231431	1	5
34A517010001	10,00	400	300	9002740231448	1	5
34A517012001	12,00	400	300	9002740231455	1	5
34A517013001	13,00	400	300	9002740231462	1	5
34A517014001	14,00	400	300	9002740231479	1	5
34A517016001	16,00	400	300	9002740231486	1	5
34A517018001	18,00	400	300	9002740231493	1	5
34A517020001	20,00	400	300	9002740231509	1	5
34A517022001	22,00	400	300	9002740231516	1	5

### Lengte-Longueur 600/500 mm

Ref.	∅ mm	l1 mm	l2 mm	Bar code EAN13	Inh-Cont.	
34A617008001	8,00	600	500	9002740232322	1	5
34A617010001	10,00	600	500	9002740232339	1	5
34A617012001	12,00	600	500	9002740232346	1	5
34A617014001	14,00	600	500	9002740232360	1	5
34A617016001	16,00	600	500	9002740232377	1	5
34A617018001	18,00	600	500	9002740232384	1	5
34A617020001	20,00	600	500	9002740232391	1	5





# Doe het zelf Gamma Gamme sachets



# Doe het zelf Gamma - Gamme sachets

## Fix-Ring

Bevestiging voor leidingen en buizen  
Fixation de gaines et tubes

Ref.	Beschrijving Désignation	Hoev.zakje Qté.sachet	Hoev.Karton Qté.carton	Barcode Gencod
A863450	Ø16 enkel - simple	25	15	3509098634502
A863500	Ø20 enkel - simple	25	15	3509098635004
A863580	Ø25 enkel - simple	25	10	3509098635806
A863710	Ø 16 dubbel - double	25	10	3509098637107
A863750	Ø 20 dubbel - double	25	10	3509098637503
A863780	Ø 25 dubbel - double	25	8	3509098637800
A863795	Ø 20 vierdubbel-quadruple	15	10	3509098637954
A863798	Ø 25 vierdubbel-quadruple	10	10	3509098637985



## Fix-Ring Elec Ø6

Bevestiging voor elektrische buizen  
Attache pour fixation de tubes électriques

Ref.	Beschrijving Désignation	Hoev.zakje Qté.sachet	Hoev.Karton Qté.carton	Barcode Gencod
A863385	Fix-Ring elec Ø16	10	30	3509098633857
A863390	Fix-Ring elec Ø20	10	30	3509098633901



## Fix-Ring MULTI

Bevestiging voor leidingen en buizen  
Fixation de gaines et tubes

Ref.	Beschrijving Désignation	Hoev.zakje Qté.sachet	Hoev.Karton Qté.carton	Barcode Gencod
A862910	Ø16 -20 DB Grijs/Gris	15	10	3509098629102
A862930	Ø16 -20 Vierd.Quadr.Grijs/Gris	5	10	3509098629300
A862960	Ø16 -20 DB Wit/Blanc	15	10	3509098629607
A862980	Ø16 -20 Vierd.Quadr.Wit/Blanc	5	10	3509098629805



## Tub-Ring

Bevestiging sanitaire en elektrische buizen  
Fixation pour tubes électrique et sanitaires

Ref.	Beschrijving Désignation	Hoev.zakje Qté.sachet	Hoev.Karton Qté.carton	Barcode Gencod
A854110	Ø15-16 enkel - simple	10	20	3509098541107
A854120	Ø20 enkel - simple	10	20	3509098541206
A854130	Ø25-26 enkel - simple	10	15	3509098541305
A854210	Ø15-16 dubbel -double	10	15	3509098542104
A854220	Ø20 dubbel -double	10	10	3509098542203
A854230	Ø25-26 dubbel -double	10	10	3509098542302



<b>Eco-Ring</b>		Verbinding Mof Manchon de raccordement			
Ref.	Beschrijving	Hoev.zakje	Hoev.Karton		Barcode
	Désignation	Qté.sachet	Qté.carton		Gencod
A320040	Eco-Ring Ø16	15	20		3509093200405
A320050	Eco-Ring Ø20	15	20		3509093200504

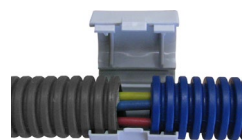

<b>Clou-Elec</b>		Befestiging van goten Attache pour la fixation de goutte			
Ref.	Beschrijving	Hoev.zakje	Hoev.Karton		Barcode
	Désignation	Qté.sachet	Qté.carton		Gencod
A859040	Clou Elec Ø6	100	20		3509098590402



<b>Fast-Ring</b>		Verbindingklem van buis op bestaande buis Attache pour tube sur tube existant			
Ref.	Beschrijving	Hoev.zakje	Hoev.Karton		Barcode
	Désignation	Qté.sachet	Qté.carton		Gencod
A854010	Ø 16 - 16	10	20		3509098540100
A854020	Ø 20 - 20	10	20		3509098540209



<b>Plug TR Cheville</b>		Plug TR Cheville TR			
Ref.	Beschrijving	Hoev.zakje	Hoev.Karton		Barcode
	Désignation	Qté.sachet	Qté.carton		Gencod
A858740	Ø 8 X 68	25	30		3509098587402



<b>Fix-Ring +</b>		Befestiging van elektrische buizen Attache pour fixation de tubes électriques			
Ref.	Beschrijving	Hoev.zakje	Hoev.Karton		Barcode
	Désignation	Qté.sachet	Qté.carton		Gencod
A863910	Fix-Ring + Ø 16	25	10		3509098639101
A863930	Fix-Ring + Ø 20	25	10		3509098639309



<b>Fix-Elec</b>		Befestiging van kleine goten Attache pour fixation de petites gouttes			
Ref.	Beschrijving	Hoev.zakje	Hoev.Karton		Barcode
	Désignation	Qté.sachet	Qté.carton		Gencod
A859010	Fix-Elec Ø5	50	20		3509098590105



<b>Bevst. Kit fixat.</b>		Bevestiging Kit Kit de fixations			
Ref.	Beschrijving	Hoev.zakje	Hoev.Karton		Barcode
	Désignation	Qté.sachet	Qté.carton		Gencod
<b>A853035</b>	Kit	4	15		3509098530354



<b>Plug Cheville CDM</b>		Bevestiging M8 2X pluggen-ringen-schroeven Attache M8 2x chevilles-rondelles-écrous			
Ref.	Beschrijving	Hoev.zakje	Hoev.Karton		Barcode
	Désignation	Qté.sachet	Qté.carton		Gencod
<b>A160600</b>	M8	2	20		3509091606001



<b>Rapido</b>		Voor ophanging in Beton (zonder plug ) Piton de suspension direct Béton(pas de cheville)			
Ref.	Beschrijving	Hoev.zakje	Hoev.Karton		Barcode
	Désignation	Qté.sachet	Qté.carton		Gencod
<b>A853350</b>	Rapido M6	20	20		3509098533508
<b>A853360</b>	Rapido M8	20	20		3509098533607
<b>V103005</b>	Dopsleutel -Douille Rapido	1	10		3509092703457



<b>RAPID M6</b>					
Ref.	Beschrijving	Hoev.zakje	Hoev.Karton		Barcode
	Désignation	Qté.sachet	Qté.carton		Gencod
<b>A853540</b>	Sluitring Rapid M6 + Kipanker- Rondelle Rapid M6 + Bascule	10	10		3509098535403



Zeskantkop-Tête Hexagonal TH 13mm + Torx T40

<b>Plug-Cheville CQLT-R Ø10</b>					
Ref.	Beschrijving	Hoev.zakje	Hoev.Karton		Barcode
	Désignation	Qté.sachet	Qté.carton		Gencod
<b>A851210</b>	Plug-Cheville CQLT-R Ø 10 X 80	10	15		3509098512107
<b>A851220</b>	Plug-Cheville CQLT-R Ø 10 X 100	10	15		3509098512206
<b>A851230</b>	Plug-Cheville CQLT-R Ø 10 X 120	10	15		3509098512305

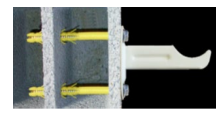

<b>Plug-Cheville US</b>		Universele Plug - Cheville Universele		
Ref.	Beschrijving Désignation	Hoev.zakje Qté.sachet	Hoev.Karton Qté.carton	Barcode Gencod
A858682	Plug-Cheville Ø6X30	25	10	3509098586825
A858684	Plug-Cheville Ø8X40	25	10	3509098586849
A858686	Plug-Cheville Ø10X50	25	10	3509098586863
A858688	Plug-Cheville Ø12X60	15	10	3509098586887



### Plug-Cheville RMT Ø8 TORX T30

Ref.	Beschrijving Désignation	Hoev.zakje Qté.sachet	Hoev.Karton Qté.carton	Barcode Gencod
A801202	Plug-Cheville RMT Ø8X60	10	10	5425003485008
A801219	Plug-Cheville RMT Ø8X80	10	10	5425003485022
A801226	Plug-Cheville RMT Ø8X100	10	10	5425003485046
A801233	Plug-Cheville RMT Ø8X120	10	10	5425003485060
A801240	Plug-Cheville RMT Ø8X140	10	10	5425003485084



### Sanitair Bevestiging-Fixations Sanitaire

Ref.	Beschrijving Désignation	Hoev.zakje Qté.sachet	Hoev.Karton Qté.carton	Barcode Gencod
A500090	Ø 8X110	2	20	3509095000904
A500120	Ø 10X140	2	15	3509095001208
A500230	Ø 6X70 INOX	2	20	3509095002304



### PRATICO

### Magnetisch gereedschap-Outil aimanté

Ref.	Beschrijving Désignation	Hoev.zakje Qté.sachet	Hoev.Karton Qté.carton	Barcode Gencod
U160000	Pratico	1	10	3509091600009





## Presentatie-Présentation

### Zakjes - Sachets

Geef een goed overzicht van de producten. Permettent un bon aperçu des produits  
Sterk en bestendig . Solides et résistants



### Onze labels :

Nieuw ontwerp : technische etiketten in kleur.  
Geïllustreerd met talrijke foto's.  
Eenvoudig en snel te lezen

### Nos étiquettes :

Nouveau design : étiquettes techniques en couleur.  
Illustrées par de nombreux visuels.  
Simples et rapides de lecture .

**FIX-RING®**  
Attache pour la fixation de gaines et tubes  
Bevestiging voor leidingen en buizen

**Ø16**

Qté : 25 Réf : A863450

### PRATICO®

OUTIL AIMANTÉ  
MAGNETISCH  
GEREEDSCHAP

Différentes applications :  
Verschillende toepassingen :

“CLIC”  
Le clip tient tout seul !  
De clip houdt vanzelf vast !

Une nouvelle façon de poser : facile!  
Een nieuwe manier van plaatsen: eenvoudig !

- Clip Beënde Spantkl em
- Cheville Gold plug
- Poi Ntag al
- Vis Vijs
- Ecrou Moer

x 1 U160000



### Distributie dozen - Les boîtes distributrices

Ze zijn voorgesneden en dus handig om ze in de rekken te plaatsen.  
Sont prédécoupées et donc pratiques pour la mise en rayon.



**arymex**

**FIX-RING®** Attache pour la fixation de gaines et tubes  
Bevestiging voor leidingen en buizen

**Ø16**

Qté : 15 Zakjes - Sachets Réf : A863450